

TMAX™

Multi-Channel High Speed Data Acquisition System

Operations Manual

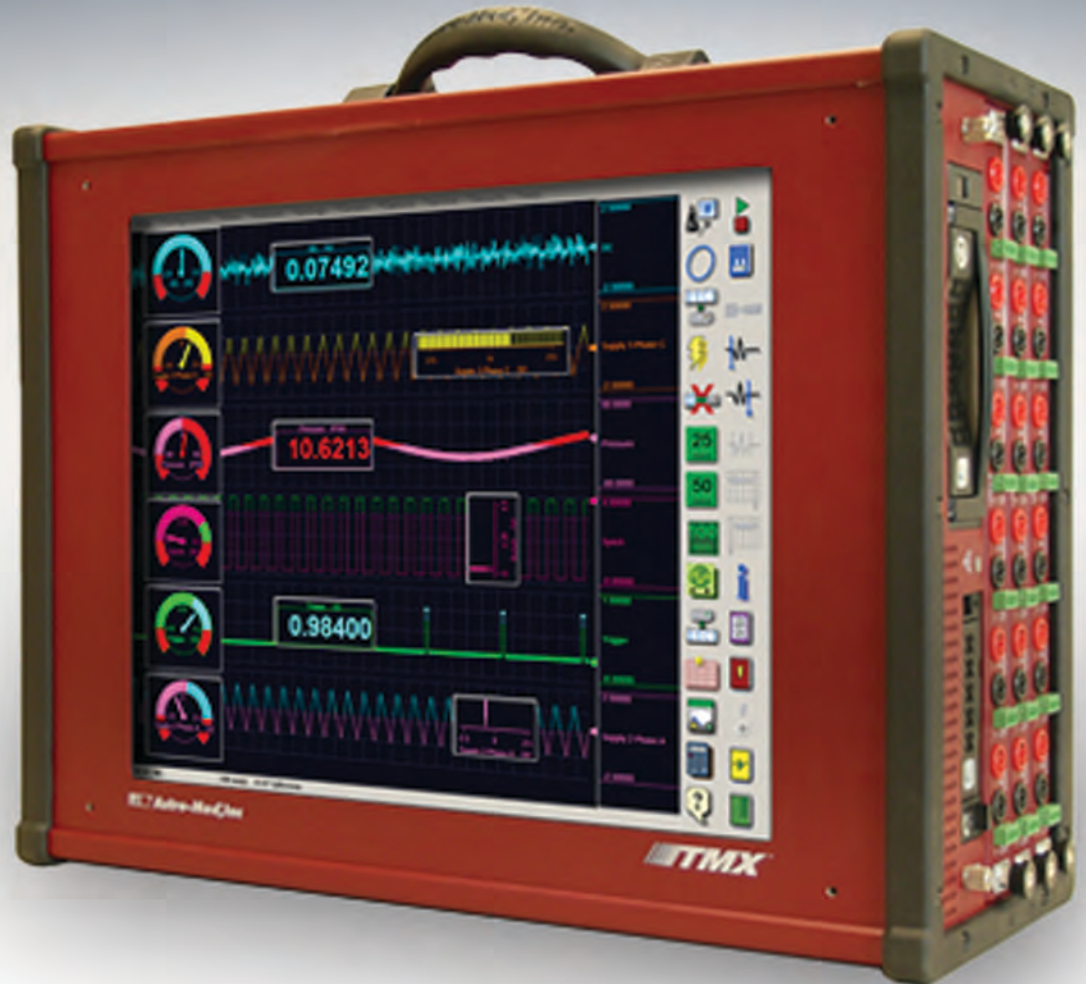

Part No. 1234567

TMX Operations Manual

Part Number: 22834578-EN-E
Manual Version 1.6

2/2011

Specifications are subject to change without notice

Astro-Med, Inc.
600 East Greenwich Avenue
West Warwick, RI 02893
401-828-4000

Technical Support 877-867-9783
techserv@astromed.com

Copyright © 2011 Astro-Med, Inc.

This manual is copyrighted with all rights reserved. No part of this document may be reproduced, transmitted, transcribed, stored in a retrieval system, or translated into any language in any form by any means without prior written permission of Astro-Med, Inc.

Trademarks

TMX and AstroVIEW X are trademarks of Astro-Med, Inc.

Microsoft and Microsoft Windows are trademarks of Microsoft Corporation.

Adobe and Adobe Acrobat are trademarks of Adobe Systems Inc.

Ethernet is a trademark of Xerox Corporation.

FCC Compliance Statement

This device has been tested and complies with Part 15 of the FCC Rules for a Class A digital device. Operation is subject to the following two conditions:

(1) this device may not cause harmful interference; and (2) this device must accept any interference received, including interference that may cause undesired operation.

These limits are designed to provide reasonable protection against harmful interference when the equipment is operated in a commercial environment. This equipment generates, uses, and can radiate radio frequency energy; if not installed and used in accordance with the operations manual it may cause harmful interference to radio communications. Operation of this equipment in a residential area is likely to cause harmful interference in which case the purchaser will be required to correct the interference at its own expense.

Warning: Modifications to unit not expressly approved by the party responsible for compliance could void user authority to operate the equipment.

Canadian Emissions Requirements

This Class A digital apparatus complies with Canadian ICES-003.

Cet appareil numérique de la classe A est conforme à la norme NMB-003 du Canada.

Symbols Displayed on this Product



Attention, refer to manual.



Off (system shutdown).



On (system connection to mains).

General Safety Information



Please review the following safety precautions to prevent personal injury or equipment damage.

- Service must be performed by qualified service personnel.
- The disconnecting device for the TMX is the AC power inlet connector. Note that the power system will be energized even when the power switch is switched off. To ensure that the power system is de-energized, the power cord must be removed from the unit.
- Use only the specified power cord and a proper outlet with protective earth ground connection.
- Never exceed the specified mains or signal input voltages specified in Appendix A: Specifications.
- This equipment is designed for indoor use only. Never operate it in wet conditions, explosive atmospheres, or environments outside of the temperature and humidity specifications listed in Appendix A: Specifications. Proper ventilation must be provided to keep this equipment within these specifications.
- Do not use the equipment if it has visible or detectable damage. Do not use the equipment if it has been exposed to stresses beyond the limits indicated in Appendix A: Specifications.
- Using this product in a manner inconsistent with what is described in this manual may impair protections provided.

Limited Warranty

Astro-Med, Inc. warrants all portions of this hardware equipment against defects in materials or workmanship for a period of one year from the date of original purchase. If you discover a defect, Astro-Med will, at its option, repair or replace this product at no additional charge except as set forth below.

Repair parts and replacement parts will be furnished on an exchange basis and will be either reconditioned or new. All replaced parts become the property of Astro-Med. This warranty does not apply if the product has been damaged by accident, abuse, misuse, or misapplication or has been modified without the written permission of Astro-Med.

To obtain warranty services, contact Astro-Med at 401-828-4000. Astro-Med, Inc. is not responsible for your product if it is lost or damaged in transit. Astro-Med, Inc. makes no warranty either express or implied with respect to this product's fitness for a particular purpose.

Disclaimer of Warranty

This software and the accompanying files are sold "as is" and without warranties as to performance or merchantability or any other warranties whether expressed or implied. No warranty of fitness for a particular purpose is offered.

It is good practice to thoroughly test the software with non-critical data before relying on it. It is the customer's responsibility to follow proper file backup procedures in the event of data loss. Astro-Med, Inc. is not responsible for any data loss experienced in operation of this software.

Astro-Med, Inc. does not warranty that the functions contained in the software will meet your requirements or that the operation of the software will be uninterrupted or error-free. The user must assume the entire risk of using the program. Any liability of the seller will be limited exclusively to product replacement or refund of purchase price.

Contact Astro-Med, Inc.

To contact the Astro-Med, Inc. Test & Measurement Group, send us an e-mail at mtgroup@astromed.com or call 401-828-4000.

Product Identification

The software provided with your equipment is the most current available. Record the model number, serial number, and software version installed on your equipment using the following spaces. Any upgrades to resident software should also be noted as they are installed.

If for any reason you need to contact Astro-Med, Inc. regarding your purchase, you will be asked to refer to this information.

Model Number:

Serial Number:

Original Software Version:

Upgraded Software Version:

Date Installed:

Upgraded Software Version:

Date Installed:

Upgraded Software Version:

Date Installed:

Declaration of Conformity Declaration de Conformité Übereinstimmungserklärung Dichiarazione di Conformità	
ID	DoC-22834578
Manufacturer's name and address Nom et adresse du fabricant Hersteller Nome del costruttore	Astro-Med, Inc. 600 East Greenwich Avenue West Warwick, RI 02893 USA
Model No. Modèle No. Model Nr. Modello No.	TMX TMX-E
Standards to which conformity is declared Standards auquel la conformité appartient Normen für welche Übereinstimmung erklärt wird Norme per le quali si dichiara la conformità	Safety: EN 61010-1, 2nd Edition (2001) EMC: EN 61326:2006 Class A
Application of Council Directives Application des Decisions du Conseil Anwendbar für die Richtlinien Applicazione delle Direttive del Comitato	2004/108/EC 2006/95/EC
<p>I, the undersigned, hereby declare that the equipment specified above conforms to the above Directive and Standard.</p> <p>Je, Soussigné, déclare que l'équipement spécifié ci-dessus est en conformité avec la directive et le standard ci-dessus.</p> <p>Ich, der unterzeichnende erkläre hiermit, daß das oben beschriebene Gerät den vorgenannten Richtlinien und Normen entspricht.</p> <p>Il sottoscritto dichiara che l'apparecchio sopra specificato è conforme alle Direttive e Norme sopra specificate.</p>	
Steven Holbrook Quality Assurance Manager Astro-Med, Inc.	 Date of issue: <u>10/04/2010</u> Place of issue: <u>West Warwick, RI</u>
European Contact: Your local Astro-Med, Inc. Sales and Service Office. FRANCE - Astro-Med SNC, Parc d'Activities de Pissaloup, 1, rue Edouard Branly, 78190 Trappes (Tel. 331-3482-0900 Fax: 331-3482-0571 Email: AstroMedFrance@astromed.com) GERMANY - Astro-Med GmbH, Senefelderstrasse 1/T6, D-63110 Rodgau (Tel. +49(0)6106-28368-0 Fax: 49-6106-771121 Email: AstroMedDeutschland@astromed.com) UNITED KINGDOM - Astro-Med, Inc., Astro-Med House, 11 Whittle Parkway, Slough, SL1 6DQ. (Tel. 44-1628-668836 Fax: 44-1628-664994 Email: AstroMedUK@astromed.com)	

Contents

Chapter: 1	Getting started	1
	Introduction	1
	Modes of operation	1
	Data capture introduction	3
	User interface introduction	3
	Help features	4
	Using context help	4
	Using icon help	5
	Viewing the operations manual PDF	5
	Technical support	5
	Viewing the software version number	6
Chapter: 2	Hardware overview	7
	Hardware diagrams	7
	Front view	7
	Left side view	8
	Right side view	10
	Drive module removal and installation	11
	Removing drive modules	11
	Installing drive modules	11
	Utility / DIO port pin configuration	12
	Uncommitted current input buffers (High voltage logic buffer)	16
	Using the stand	17
	Using the display cover	18
	TMX-R Rack mount model	19
	TMX-R Front view	20
	TMX-R Back view	21
	Using the hard transport case	22
Chapter: 3	Input modules	23
	Input module locations	23
	Input module installation and removal	23
	Installing input modules	24
	Removing input modules	24
	UNIV-6 - Universal voltage module with DC bridge	25
	UNIV-6 Single ended inputs	25
	UNIV-6 Differential / DC bridge inputs	26
	UNIV-6 DC bridge wiring diagrams	26
	NIDV-16 - Non-isolated differential voltage module	27
	NIDV-16 Differential inputs	28
	IHVM-6 - Isolated high voltage differential input module	29
	IHVM-6 Differential inputs	29
	ITCU-12 Universal thermocouple amplifier	30
	ITCU-12 Temperature ranges	30
	Thermocouple application notes	31
	Thermocouple composition	31
	Thermocouple wire coloring standards	32

Chapter: 4	Optional hardware	33
	Installing a mouse and keyboard	33
	USB memory devices	33
	Installing the USB external hard drive (EHD-USB)	33
	Installing the USB flash memory drive	33
	External monitor	34
	Installing an external monitor using the touch-screen	34
	Installing an external monitor using a mouse	35
	Installing Windows-based printers	36
	TMX-E	38
	TMX-E input module locations	38
	Installing the TMX-E	39
	Real-Chart NP printer	39
	Connecting the TMX and Real-Chart NP	40
	Printing with the Real-Chart NP	40
	TMX-IRIG/GPS	42
	Connecting a time source with the TMX-IRIG/GPS option	44
	Selecting and calibrating the TMX-IRIG/GPS time code	44
	Working with the TMX-IRIG/GPS time code	46
	AstroDock TMX	47
Chapter: 5	Menus and icons	49
	Menu bar	49
	Locking the menu bar	49
	Common system icons	49
	Control panel	50
	Customizing the control panel	51
	Control panel setup files	52
	Saving control panel setup files	52
	Loading control panel setup files	53
	Loading control panel setup files with the control panel	53
Chapter: 6	Channel setup	55
	Channel setup concepts	55
	Signal inputs	58
	Channel Settings window overview	58
	Setting up amplifier inputs	60
	Setting up amplifier input filters	62
	Setting up a frequency counter	65
	Automatically balancing bridge inputs	67
	Setting up base channels	69
	Derived channels	70
	Derived channel syntax	71
	Derived channel examples	71
	Setting up derived channels	72
	Engineering units	74
	Setting up engineering units	75
	Setting up engineering units based on DC levels	76
	Setting up event inputs	77
	Signal setup files	78
	Saving signal setup files	78
	Loading signal setup files	79

	Loading signal setup files with the control panel	79
Chapter: 7	Display setup	81
	Display Wizard	81
	Using the Display Wizard	81
	Grids	82
	Adding grids	82
	Editing grids	83
	Moving grids	83
	Resizing grids	84
	Removing grids	84
	Selecting a color for all grids	84
	Selecting a background color	85
	Events	85
	Event styles	85
	Adding events	85
	Editing events	86
	Moving events	86
	Removing events	87
	Showing and hiding pens, channel limits, and the control panel	87
	View setup files	88
	Saving view setup files	88
	Loading view setup files	89
	Loading view setup files with the control panel	89
Chapter: 8	Realtime mode	91
	Realtime mode introduction	91
	Accessing Realtime mode	91
	Freezing and running the monitor	91
	Realtime mode default control panel	91
	Setting up Realtime mode	93
	Realtime mode view options	93
	Printing signal IDs	93
	Printing a full-page mark	94
	Viewing real-time video	94
	Global setup files	94
	Saving global setup files	95
	Loading global setup files	95
	Loading global setup files with the control panel	96
Chapter: 9	Data capture	97
	Data capture overview	97
	Data capture concepts	97
	Data capture process	98
	Data capture setup	99
	Setting up a data capture	100
	Setting up the IRIG time code using the TMX-TTLIRB option	102
	Setting up a video capture	103
	Triggers and aborts	104
	Enabling and disabling triggers and aborts	105
	Trigger Settings window overview	107
	AND/OR triggers/aborts	108

- Setting up a Window trigger/abort 108
- Setting up an Edge trigger/abort 109
- About Slew triggers/aborts 111
- Setting up a Slew trigger/abort 112
- Event triggers/aborts 113
 - Setting up an Event trigger/abort 113
- Periodic and time triggers 115
 - Setting up a Periodic trigger 116
 - Setting up a Time trigger 116
- Performing a data capture 117
 - Adding notes to data captures 118
 - Recording audio in data captures 119
- Capture setup files 119
 - Saving capture setup files 120
 - Loading capture setup files 120
 - Loading capture setup files with the control panel 121
- Trigger setup files 121
 - Saving trigger setup files 122
 - Loading trigger setup files 123
 - Loading trigger setup files with the control panel 123
- Formatting the data capture drive 124

Chapter: 10

- Scope mode 127
 - Scope mode introduction 127
 - Accessing Scope mode 127
 - Using the track view 127
 - Displaying the trigger line 128
 - Displaying channel IDs 129
 - Scope mode default control panel 129
 - Scope captures 130
 - Setting up a scope capture 130
 - Performing a scope capture 132
 - Embedded scope captures 133
 - Setting up embedded scope captures 134
 - Archiving scope captures 136
 - Archiving as data capture records in Scope mode 137

Chapter: 11

- Review mode 139
 - Review mode introduction 139
 - Accessing Review mode 139
 - LookBack review 141
 - Loading a new file 141
 - Loading the next/previous file 142
 - Viewing file information 142
 - Deleting files 143
 - Review mode default control panel 144
 - File scrolling and navigation 144
 - Using the track view 145
 - File navigation control panel icons 145
 - File navigation menu options 145
 - Using advanced search 146
 - File compression 147
 - Showing all of the file 147

Setting a compression	147
Setting an expansion	148
Review mode view options	148
Selecting a status text format	148
Displaying the trigger line	149
Displaying channel IDs	149
Viewing and editing notes	149
Adding notes	150
Playing audio	150
Viewing embedded scope captures	152
Viewing video during review	153
Saving the Review mode view as default	153
Review mode channel setup	154
Review Channel Settings window overview	154
Setting up Review mode filters	155
Review mode derived channels	157
Saving the Review mode channels as default	158
Archiving files in Review mode	158
Archiving as data capture records in Review mode	158

Chapter: 12 Analysis tools 161

Cursors	161
Measuring channels with cursors	161
Channel meters	164
Channel meter types	164
Adding channel meters	165
Editing channel meters	166
Moving channel meters	166
Resizing channel meters	166
Removing channel meters	166
XYX plots	167
Adding XYX plots	167
Editing XYX plots	168
Moving XYX plots	168
Resizing XYX plots	168
Using XYX plot cursors	169
Removing XYX plots	169
XYX plot templates	170
Creating XYX plot templates	170
Loading XYX plot templates	172
Adjusting XYX plot templates	172
Fourier Transform window	173
Adding Fourier Transform windows	173
Editing Fourier Transform windows	174
Moving Fourier Transform windows	174
Resizing Fourier Transform windows	174
Using Fourier Transform window cursors	174
Removing Fourier Transform windows	175
Zoom window	175
Adding Zoom windows	175

Chapter: 13 Networking and communications 177

IP information	177
--------------------------	-----

	Modifying IP information	177
	Copying files from the system drive to a USB or network drive	178
	File transfer protocol (FTP)	179
	Using FTP applications	180
	TMX folders and files	180
Chapter: 14	Utilities and service options	183
	Utilities screen	183
	Restoring default settings	183
	Showing and hiding the cursor	184
	Selecting a language	184
	General utilities	185
	Calibrating the touch screen	185
	Upgrading the system software	186
	Calibrating channels	186
	Viewing factory calibration data	188
	Application utilities	188
	Using the Launch utility	189
	Using the Operating System utility	190
	Setting the system time	190
	Changing passwords	190
	Changing the system password	191
	Changing the calibration password	191
	Viewing and modifying utility / DIO port settings	191
	Using the calculator	192
	Selecting a video standard	192
Chapter: 15	TMX offline software	195
	TMX offline overview	195
	TMX offline installation	195
	File transfer	195
	Selecting offline input modules	196
Appendix: A	Specifications	197
	Color display	197
	Signal modules	197
	Utility / DIO port	197
	UNIV-6 module	197
	NIDV-16 module	200
	IHVM-6 module	202
	ITCU-12	204
	Data acquisition	205
	Power	206
	Optional DC power	206
	Physical	206
	TMX-R	207
	TMX-E	207
	TMX-VA Optional Software	207
	TMX-IRIG/GPS Option	208
Appendix: B	Icon descriptions	209

Common system icons209
Realtime mode control panel209
Scope mode control panel212
Review mode control panel215

1

Getting started

Introduction

The TMX is a versatile, high-frequency data acquisition recording system that provides the capability to display, record, and review waveform data.

The TMX utilizes a touch-screen as the main user interface. Many of the control buttons are customizable, providing the capability to modify the display based on the needs of the user or application.

Modes of operation

The operating modes are Realtime, Scope, and Review modes.

- **Realtime mode** - Realtime mode provides real-time waveform scrolling, monitoring, and data capture capabilities, typically used to view low frequency waveforms. Additionally, almost all system setup options are accessible from Realtime mode.

Choose Configuration >> Realtime from the menu bar to access Realtime mode.

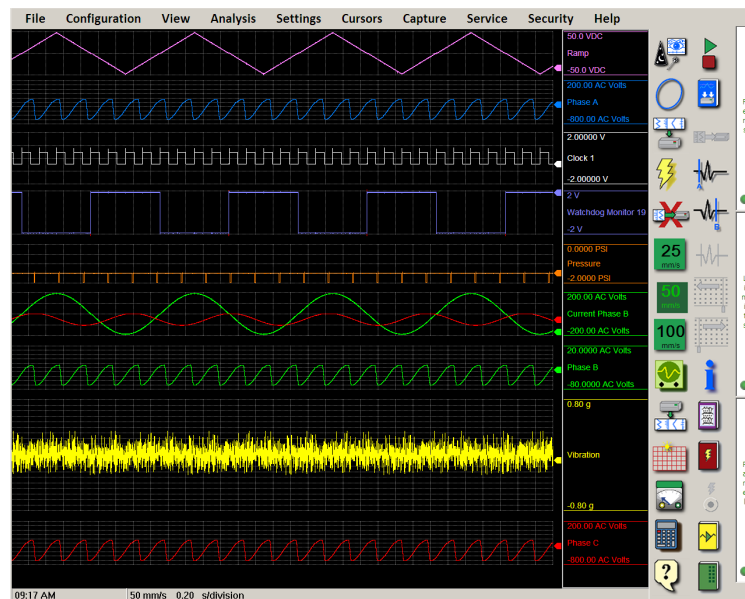

- **Scope mode** - Scope mode acts like a digital storage oscilloscope, providing high time-base resolution for viewing high-frequency signals. Scope mode is useful for timing and synchronization analysis, transient capture, and high-speed testing. It

can be used while continuously capturing data and monitoring signals on the display.

Choose Configuration >> Scope from the menu bar to access Scope mode.

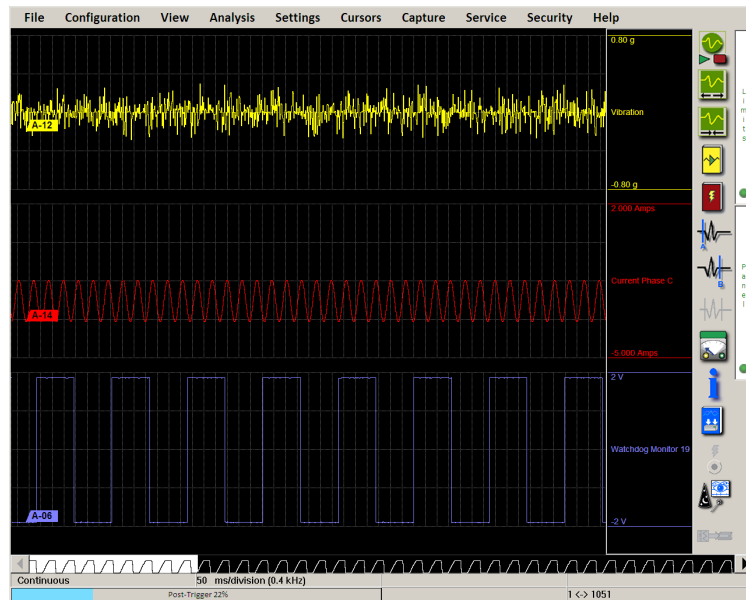

- **Review mode** - Review mode provides the capability to review and analyze saved data capture and scope capture files. It also provides file management features.

Choose Configuration >> Review from the menu bar. A file selection window will open. Select a file to review and choose OK.

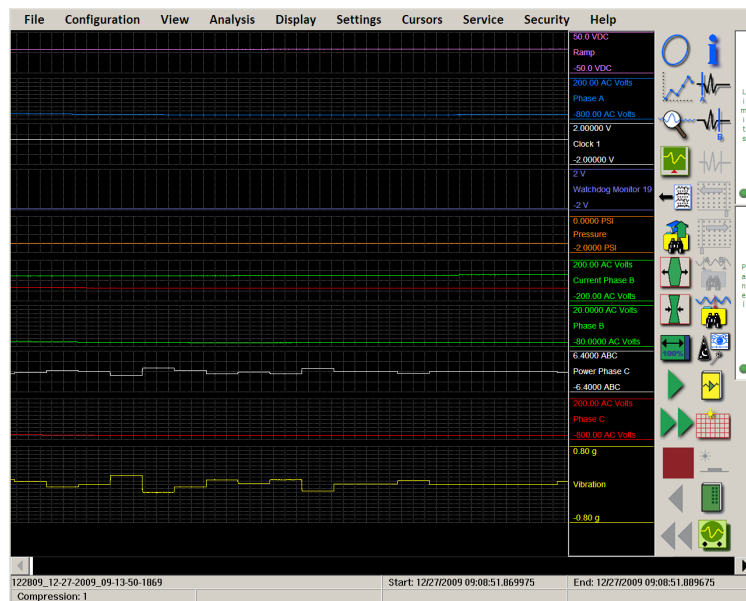

Data capture introduction

There are two hard drives in the TMX. The system drive contains the Windows operating system of the recorder. The data capture drive is used to record streaming data.

During the data capture process, data is recorded directly to the data capture drive. When the data capture is complete, you can review the data file on the TMX using review mode.

If you want to export the data from the data capture drive, you can archive the data capture file to the system drive or directly to a USB storage device.

The TMX archive feature ensures data integrity and is the only method of exporting files from the data capture drive. The data capture drive is not accessible from Windows Explorer on the system drive.

User interface introduction

The menu bar and control panel displayed on the touch-screen provide access to the controls and settings. Host control options are also available.

- **Menu bar** - The menu bar is a group of drop-down menus located across the top of the display. All modes and features can be accessed from this menu. Menu options will vary based on the mode of operation (Realtime, Scope, or Review) used.

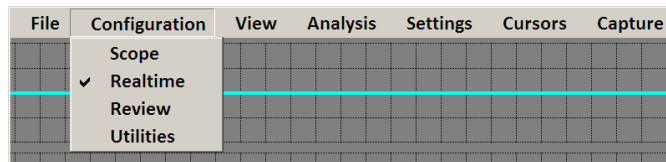

Note: The “>>” symbol in this manual indicates selections made using the menu bar. For example, “Configuration >> Realtime” indicates to choose Configuration, then Realtime from the menu bar.

- **Control panel** - The control panel is a customizable group of icon buttons located on the right side of the display. It provides immediate access to virtually any

function with one touch. Each mode of operation (Realtime, Scope, and Review) utilizes its own control panel.

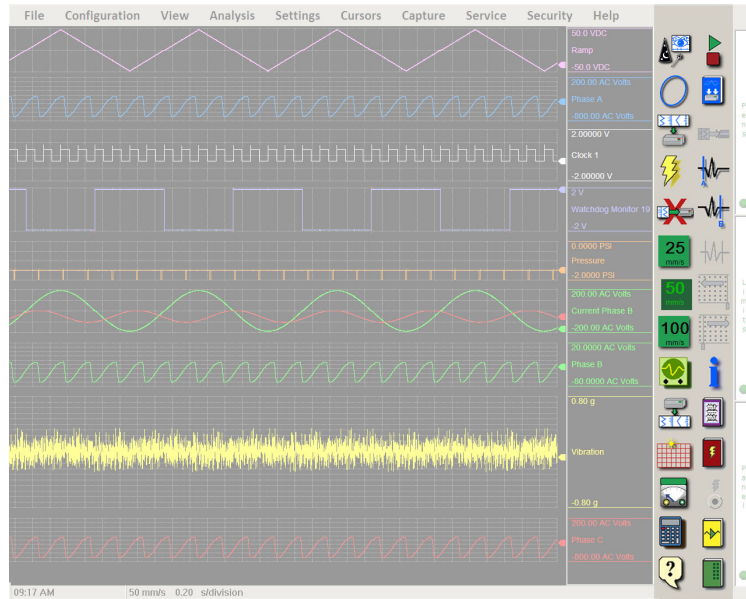

- **Host control** - The recorder can be controlled remotely via a network connection and host commands. For more information, please contact Technical Support for the TMX Host Control Guide.

Help features

Context help, icon help, and the online manual are available to help you learn more about the recorder.

Using context help

The context help feature provides on-screen help based on the activity being performed in a window.

- 1 Choose the Context Help button from an open window.

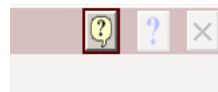

Context help instructions for the current task will appear.

- 2 To close the help, choose Cancel in the help window.



Using icon help

The icon help feature provides brief on-screen descriptions for icons.

- 1 To use icon help in the main Realtime, Scope, or Review mode screens, choose Help >> Icon Help.

Touch and hold a control panel icon. A short description of the icon will appear.

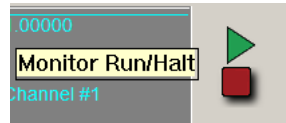

To exit icon help, choose Help >> Icon Help again.

Note: Remember to deactivate the icon help function after using it, as icons will not perform their functions when icon help is active.

- 2 To use icon help in an open window, choose the Icon Help button.



Touch and hold an icon in the window. A short description of the icon will appear.

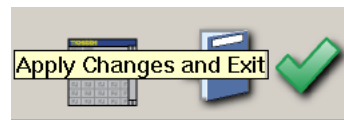

To exit icon help, choose the Icon Help button again.

Note: Remember to deactivate the icon help function after using it, as icons will not perform their functions when icon help is active.

Viewing the operations manual PDF

The Adobe Portable Document Format (PDF) version of this manual is available for on-screen viewing.

- 1 Choose Help >> Operations Manual. Adobe® Acrobat® Reader will launch and the online version of this manual will be opened.
- 2 To exit the online manual, close Adobe Acrobat Reader.

Technical support

For additional assistance, contact Astro-Med, Inc. Technical Support via telephone toll-free at 1-877-867-9783 (U.S. and Canada only) or e-mail at techserv@astromed.com.

Please have the serial number of the unit available when contacting support.

Viewing the software version number

Use the About window to view the version number of the software currently installed on the system.

- 1** Choose Help >> About.

2

Hardware overview

Hardware diagrams

This section provides a visual overview of the hardware characteristics of the recorder. In addition to the diagrams, brief descriptions are included on various components.

Front view

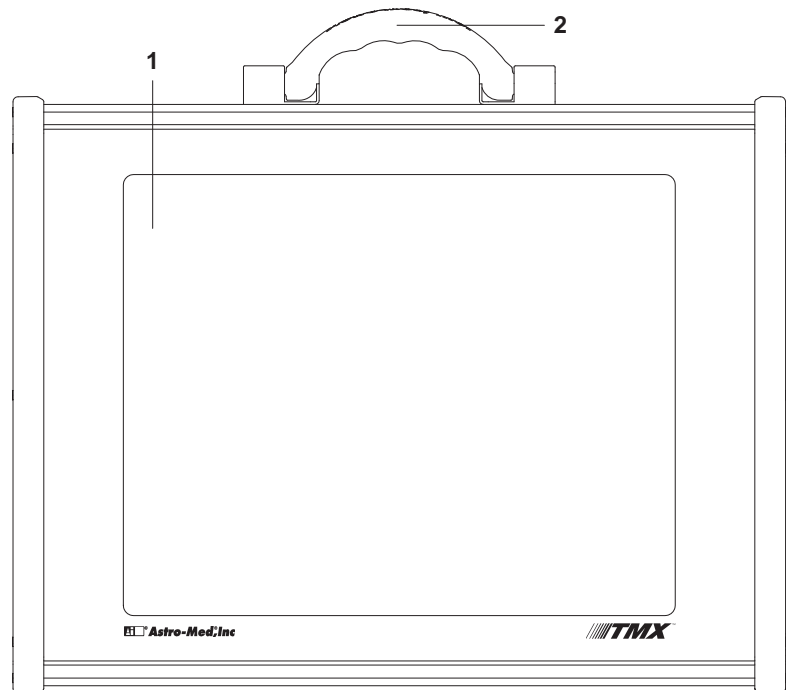

#	Description
1	<p>Touch screen</p> <p>The touch screen is the main user interface for the recorder. Touch the display with your fingertip or a stylus to select on-screen menus and buttons.</p> <p><i>Note: To clean the touch-screen, dampen a soft cloth with window cleaner or water. Then gently clean the screen using the cloth. Cleaner should be sprayed on the cloth and not directly on the touch-screen. Spraying cleaner on the touch-screen could result in damage from liquid draining into the system.</i></p>
2	<p>Carry handle</p> <p>Use the carry handle to move the recorder.</p>

Left side view

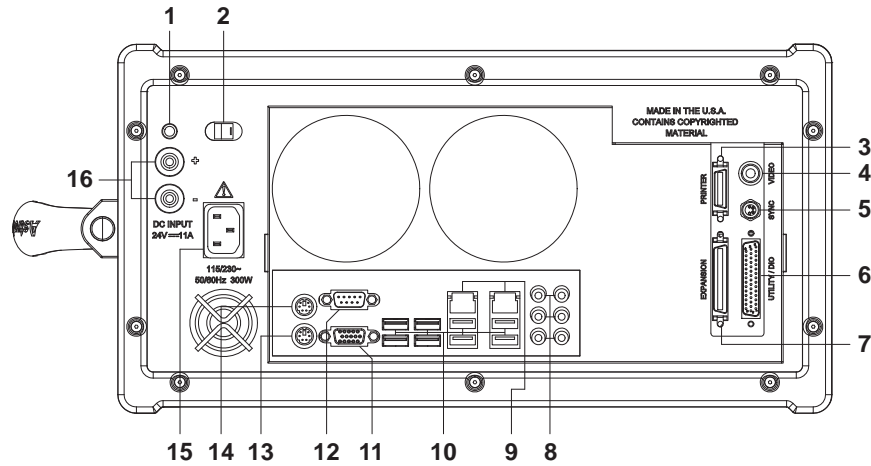

#	Description
1	Power indicator light This light visually indicates the power status of the recorder. When the recorder is operating properly with full power, the indicator will remain lit. During the power-down sequence, it will pulse for a few moments until the recorder turns off.
2	Power switch Use the power switch to power up and power down the recorder. The power-up sequence requires less than one minute.
3	Reserved (do not connect) This port is reserved for factory use.
4	Video port If the TMX-VA option is enabled, you can connect an external video camera and record video during a data capture.
5	Reserved (do not connect) This port is reserved for factory use.
6	Utility / DIO port This port provides utility input/output functions and is used for event inputs.
7	Expansion port This port is used to connect the recorder to the TMX-E expansion chassis.
8	Audio ports These ports provide a variety of audio inputs and outputs for the single-board computer within the unit.

#	Description
9	<p>Ethernet ports (1000 Mbps)</p> <p>The Ethernet port is used to provide network connectivity to the unit. Once the unit is properly connected to a network via Ethernet, file transfer and host control capabilities can be used. These 1000 Mbps ports are capable of automatically switching to 10/100 Mbps speeds.</p>
10	<p>USB 2.0 ports</p> <p>The USB 2.0 ports are used to connect USB accessories to the unit, such as a portable memory storage device, keyboard, or mouse.</p>
11	<p>VGA port</p> <p>The VGA port is used to connect the recorder to an external monitor. The monitor must be capable of displaying a 1280 x 1024 screen resolution.</p>
12	<p>Reserved (do not connect)</p> <p>This port is reserved for factory use.</p>
13	<p>Keyboard port</p> <p>The keyboard port is used to connect a standard keyboard to the unit. Once connected, the keyboard can be used as an alphanumeric input device.</p>
14	<p>Mouse port</p> <p>The mouse port is used to connect a standard mouse to the unit. Once connected, the mouse can be used as a pointing and selection device.</p>
15	<p>Power inlet</p> <p>The power inlet is used to attach the power cable to the unit.</p>
16	<p>DC input</p> <p>The DC input jacks are used to connect DC power (24 VDC) to the unit.</p>

Right side view

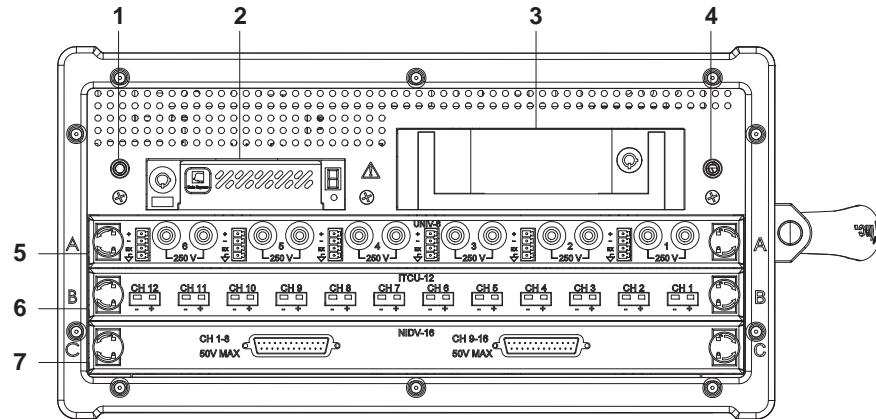

#	Description
1	Ground connection The ground connection is used to connect shields on input wiring, if needed.
2	System drive The system drive contains the Windows operating system and can be used to archive files.
3	Data capture drive The data capture drive is used to record channel samples.
4	Ground connection The ground connection is used to connect shields on input wiring, if needed.
5	Input module A slot The input module installed in this slot is identified as module A in the software.
6	Input module B slot The input module installed in this slot is identified as module B in the software.
7	Input module C slot The input module installed in this slot is identified as module C in the software.

Drive module removal and installation

The system drive (1) and data capture drive (2) modules can be unlocked and removed from the recorder. This feature allows you to remove your data for storage in a secure location.

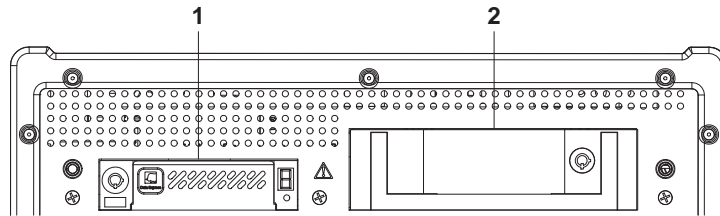

You can later reinstall the drive modules when needed. Both drive modules must be installed and locked or the recorder will not start up.

Removing drive modules

- 1 Turn the power off on the recorder.

Caution: *The hard drive modules are not hot-swappable, and should never be installed or removed while the recorder is powered on. Doing so may result in data loss or damage to the recorder.*

- 2 Insert the key into the lock and turn clockwise to unlock the drive bay.
- 3 Remove the drive.
 - To remove the system drive, press the eject button located below the lock to remove it from the bay.
 - To remove the data capture drive, pull the handle on the front of the drive to remove it from the bay.
- 4 Re-lock the drive by turning the drive key counter-clockwise.

Installing drive modules

- 1 Turn the power off on the recorder.

Caution: *The hard drive modules are not hot-swappable, and should never be installed or removed while the recorder is powered on. Doing so may result in data loss or damage to the recorder.*

- 2 Insert the key into the lock and turn clockwise to unlock the drive bay.
- 3 Slide the drive all the way into the drive bay.
- 4 Re-lock the drive by turning the drive key counter-clockwise.

Utility / DIO port pin configuration

The following diagram illustrates the utility / DIO port pin configuration. Signals have a high state (3.3V) and a low state (0V).

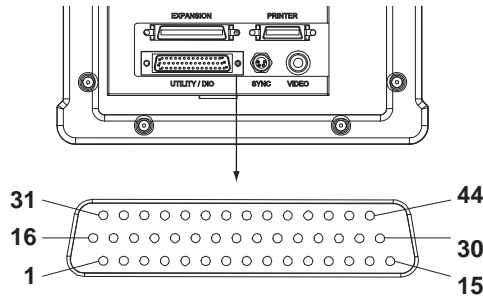

Note: All DIO outputs can source and sink 16mA.

Pin	Type	Voltage Levels	Description
1	Input	3.3V (5V tolerant)	Event 1 input
2	Input	3.3V (5V tolerant)	Event 2 input
3	Input	3.3V (5V tolerant)	Event 3 input
4	Input	3.3V (5V tolerant)	Event 4 input
5	Input	3.3V (5V tolerant)	Event 5 input
6	GND		Ground return for events or utility port functions.
7	Input	30 VRMS / 4-42 VDC peak	Common for uncommitted current input buffers 1 & 2
8	GND		Ground return for events or utility port functions.

Pin	Type	Voltage Levels	Description
9	Output	3.3V	Trigger output The trigger output pulses a low for 100 usec in response to the recorder recognizing a trigger. This line can be connected to the external trigger input line of another TMX. In this case, the TMX receiving the external trigger input signal will trigger in response to the same event as the TMX sending the trigger output signal.
10	Input	3.3V (5V tolerant)	External abort input The external abort input line provides the capability to abort any currently running data capture. A low for at least 100 ms will cause the recorder to abort any data capture in progress.
11	Output	3.3V	Programmable output 1
12	Output	5V	Fused 5V output (400 mA max)
13	GND		Ground return for events or utility port functions
14	Output	TTL	Output from uncommitted current input buffer 3
15	Input	30 VRMS / 4-42 VDC peak	Input to uncommitted current input buffer 4
16	Input	3.3V (5V tolerant)	Event 6 input
17	Input	3.3V (5V tolerant)	Event 7 input
18	Input	3.3V (5V tolerant)	Event 8 input
19	Input	3.3V (5V tolerant)	Event 9 input
20	Input	3.3V (5V tolerant)	Event 10 input
21	Input	3.3V (5V tolerant)	Event 11 input

Pin	Type	Voltage Levels	Description
22	Output	TTL	Output from uncommitted current input buffer 1
23	Input	30 VRMS / 4-42 VDC peak	Input to uncommitted current input buffer 1
24	Input	3.3V (5V tolerant)	Chart/page mark input The chart/page mark input provides the capability to place a full page mark across the display.
25	Output	3.3V	Alarm output The alarm output can be used to signal when alarm conditions for selected channels occur. The signal is low during alarm signals.
26	Input	3.3V (5V tolerant)	Print channel ID This input provides the capability to place channel IDs on the display. A low on this line for at least 100 ms will cause the selected item to be printed, provided the chart is running.
27			Reserved (do not connect to this pin)
28	Input	3.3V (5V tolerant)	External arm input The external arm input provides the capability to arm a data capture and/or scope capture using an outside signal. A low on this line for at least 100 ms will cause a capture to be armed, provided there is storage available for the capture.
29	Output	TTL	Output from uncommitted current input buffer 4
30	Input	30 VRMS / 4-42 VDC peak	Input to uncommitted current input buffer 3
31	Input	3.3V (5V tolerant)	Event 12 input
32	Input	3.3V (5V tolerant)	Event 13 input

Pin	Type	Voltage Levels	Description
33	Input	3.3V (5V tolerant)	Event 14 input
34	Input	3.3V (5V tolerant)	Event 15 input
35	Input	3.3V (5V tolerant)	Event 16 input
36	Output	TTL	Output from uncommitted current input buffer 2
37	Input	30 VRMS / 4-42 VDC peak	Input to uncommitted current input buffer 2
38	Input	3.3V (5V tolerant)	External trigger input The external trigger input provides the capability to invoke a trigger using an outside signal. A low on this line will cause an external trigger, if external triggers are enabled.
39	Input	3.3V (5V tolerant)	External sample rate input This pin provides the capability to enter a sample rate for data captures via an external signal. To use an external sample rate, external sample rate must be selected in the Capture Setup window. Sample clock must be between 10% - 90% duty cycle.
40			Reserved (do not connect to this pin)
41	Input	3.3V (5V tolerant)	Security input The security input pin provides the capability to disable the password protection security. A low on this line will disable passwords and allow full access to previously protected features.
42	Output	3.3V	Programmable Output 2
43			Reserved (do not connect to this pin)

Pin	Type	Voltage Levels	Description
44	Input	30 VRMS / 4-42 VDC peak	Common for uncommitted current input buffers 3 & 4

Uncommitted current input buffers (High voltage logic buffer)

The Utility / DIO port contains inputs for monitoring events and controlling functions such as triggering a data capture, defining a sample rate, etc. These inputs use TTL (0-5V) / LVTTTL (0-3.3V) / switch closure compatible signals. Inputs have a high state (3.3V, 5V tolerant) and a low state (0V).

If your high state control signal is greater than 5V, you cannot connect directly to the Utility / DIO port inputs. However, you can still use the signal to control a utility input by connecting via an uncommitted current input buffer. The uncommitted current input buffer provides you with an isolated logic buffer for your high voltage control signal. This buffer allows you to use a positive voltage in the 4 to 42 volt peak range as the high state control input to the utility port function.

Four buffers are provided for this purpose, allowing you to control up to four utility port inputs

The input pins for these buffers are isolated from each other, and each pin is rated for as much as 30Vrms / 42V peak voltage with respect to chassis or utility port ground (pin 6). Regardless of the magnitude of the voltage applied to these inputs, the buffers will limit current sourced from the user's signal to 4.3 mA (+/- 10%). The pins are protected against reverse voltage to -42 volts.

When wiring the buffer, use the following guidelines.

- Connect the positive control signal to a buffer input.
- Connect the negative control signal to the common corresponding with the buffer input.
- Connect the output from the corresponding buffer to the utility port input you want to control.

For example, suppose you want to control Event 6 using uncommitted current input buffer 1. The wiring would be configured as described in the following table.

From	To
Positive signal	Pin 23
Negative signal	Pin 7
Pin 22	Pin 16

In the following example diagram, events 1-4 are buffered with the uncommitted current input buffers.

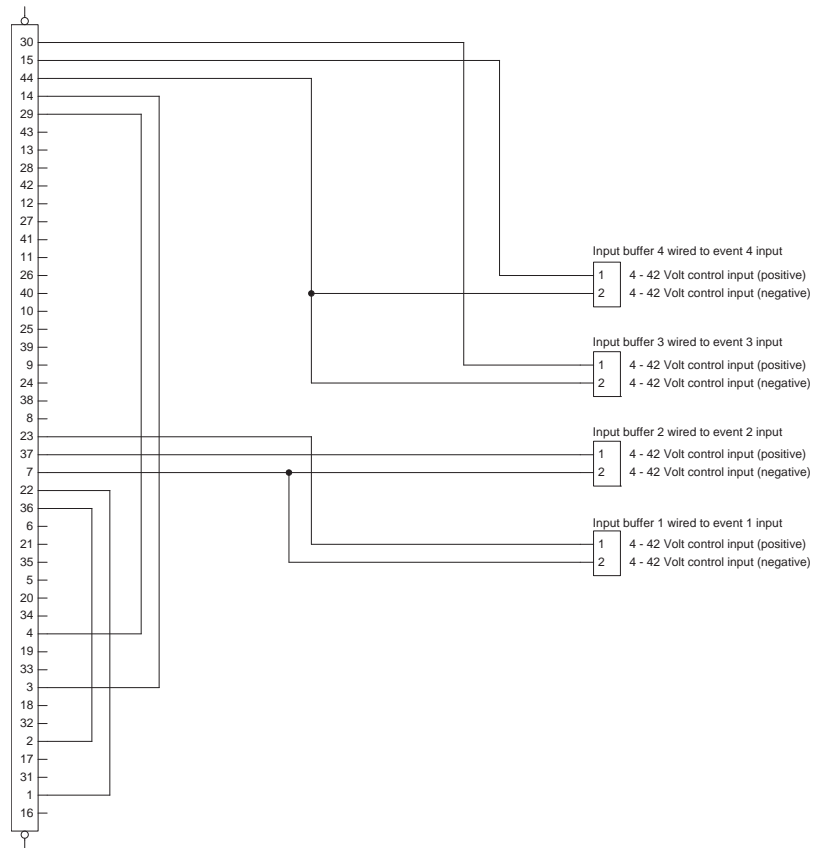

Using the stand

Use the adjustable stand to securely position the recorder at an angle.

- 1 Align the thumbscrews on the stand with the holes on the back of the recorder. Use the thumbscrews to securely fasten the stand to the recorder.

- 2 Open the stand fully and position the recorder as indicated in the following illustration. If necessary, you can adjust the stand height by rotating the leveling foot.

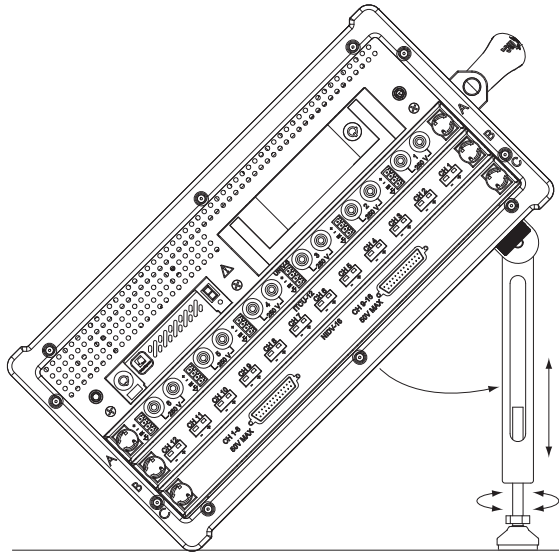

Using the display cover

If harsh conditions are part of your testing environment, you can protect the touch-screen with the transparent display cover.

- 1 Place the display cover over the touch-screen and align the thumbscrews with the holes on the front of the recorder.



- 2 Use the thumbscrews to fasten the cover into position.

TMX-R Rack mount model

The TMX-R is a rack mount version of the TMX that accepts up to six input modules.

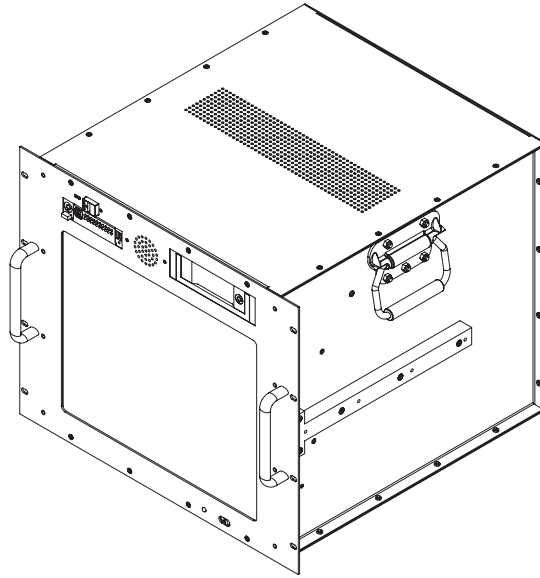

Note: The TMX-E is not compatible or necessary for use with the TMX-R. The TMX-R supports up to six input modules without the need for an expansion unit.

TMX-R Front view

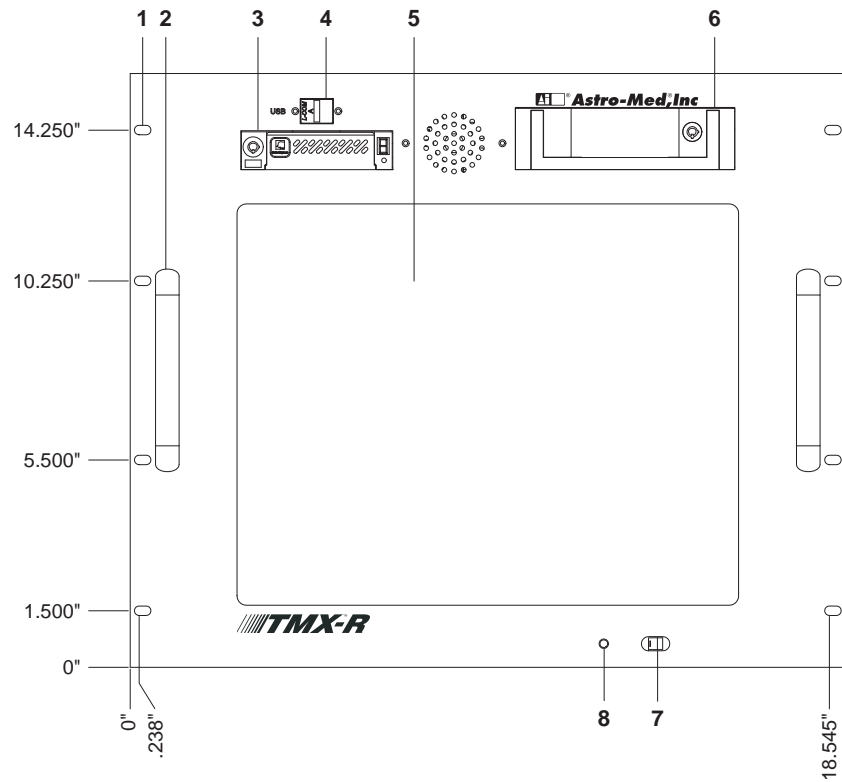

#	Description
1	Rack mounting holes
2	Handle
3	System drive
4	USB 2.0 port
5	Touch screen
6	Data capture drive
7	Power indicator light
8	Power switch

TMX-R Back view

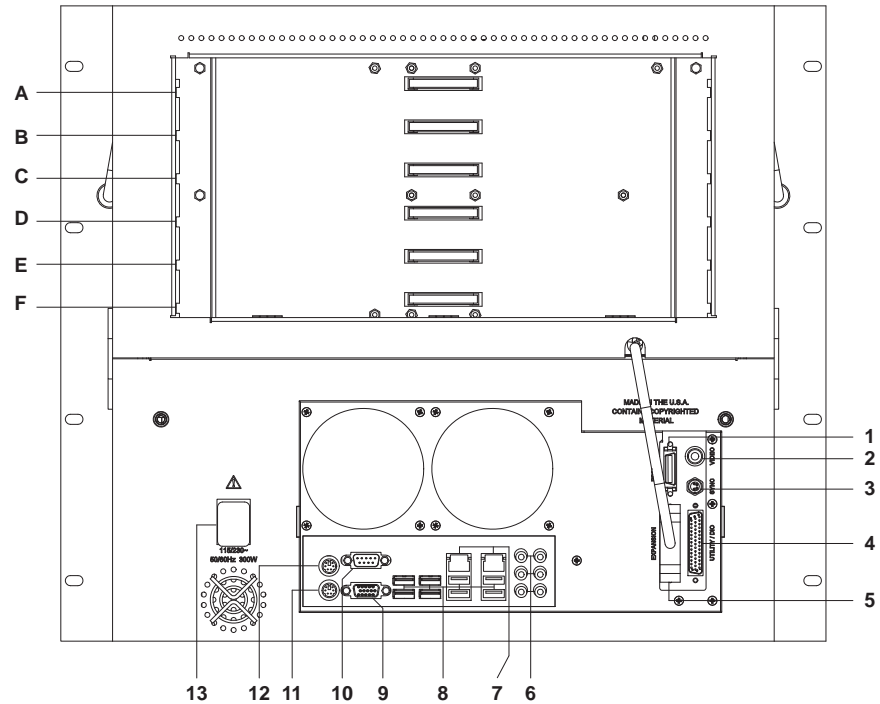

#	Description
A - F	Input module slots A to F.
1	Reserved (do not connect) - This port is reserved for factory use.
2	Reserved (do not connect) - This port is reserved for factory use.
3	Reserved (do not connect) - This port is reserved for factory use.
4	Utility / DIO port
5	Expansion port - The cable from the module area of the TMX-E must be plugged into this port.
6	Audio ports
7	Ethernet ports (1000 Mbps)
8	USB 2.0 ports
9	VGA port

#	Description
10	Reserved (do not connect) - This port is reserved for factory use.
11	Keyboard port
12	Mouse port
13	Power inlet

Using the hard transport case

The optional HC-TMX hard case can be used to protect the TMX during transport.

Note: For information about the HC-TMX case, please contact Test & Measurement Sales.

- 1 Install the display cover on the TMX.
- 2 Orient and insert the TMX into the HC-TMX as illustrated. Ensure the removable foam pad is placed against the side with the system and data capture drives.

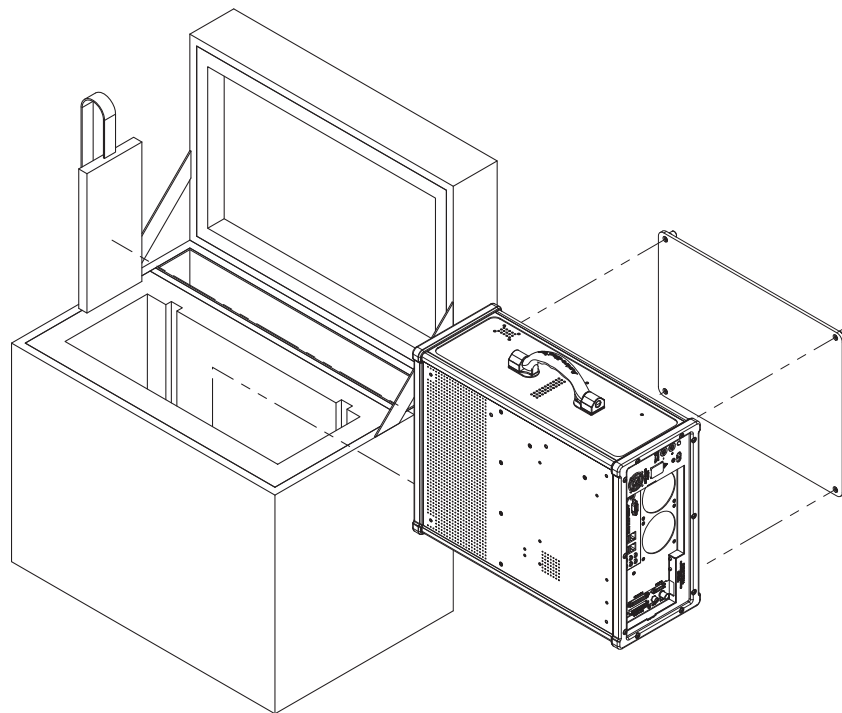

- 3 Close the HC-TMX.

3

Input modules

Input module locations

The system uses up to three modules for signal input connections. Input modules can be installed using the plug-in slots located on the side of the recorder. The slots are labeled A, B, and C for module identification in the software.

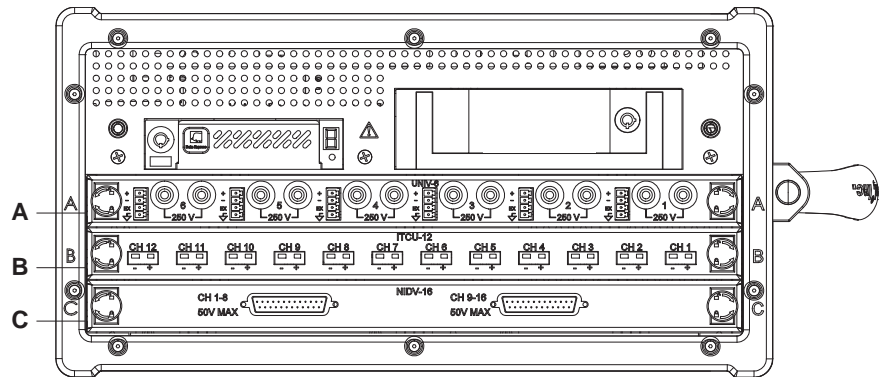

Note: The input modules displayed in this diagram are used for illustration purposes. The appearance of input modules will vary based on the module types installed.

Input module installation and removal

This section describes how to install and remove input modules.

The following diagram illustrates the connection points on input modules.

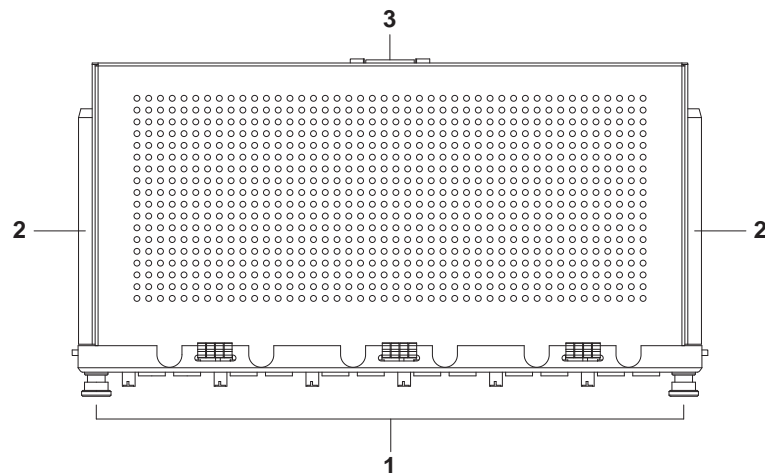

#	Description
1	Locking knobs The locking knobs are used to fasten the module into the recorder.
2	Slot guides The slot guides are used to align the module and guide it into position in the recorder.
3	Connector The connector is used to electronically connect the module to the recorder.

Installing input modules

- 1 Turn the power off on the recorder.
- 2 Position the recorder on its back with the touch-screen facing up.
- 3 Insert the input module into an empty module slot. Ensure the module slot guides are aligned with the corresponding slots in the recorder. Slide the module fully into the recorder.
- 4 Use the thumbscrews to lock the two knobs on the input module. Turn the left knob clockwise and the right knob counter clockwise.

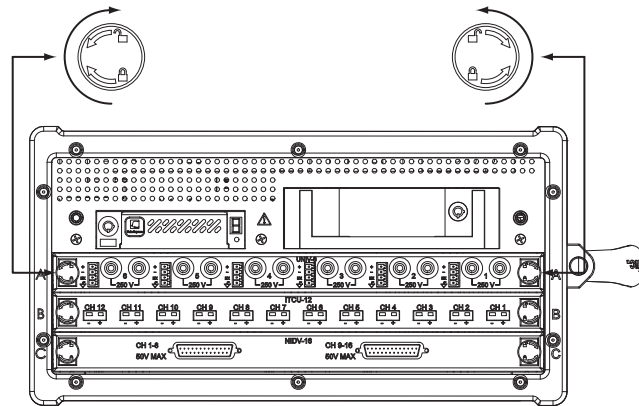

- 5 Turn the recorder power on.

Removing input modules

- 1 Turn the power off on the recorder.
- 2 Position the recorder on its back with the touch-screen facing up.

- Use the thumbscrews to unlock the two knobs on the input module you want to remove. Turn the left knob counter clockwise and the right knob clockwise.

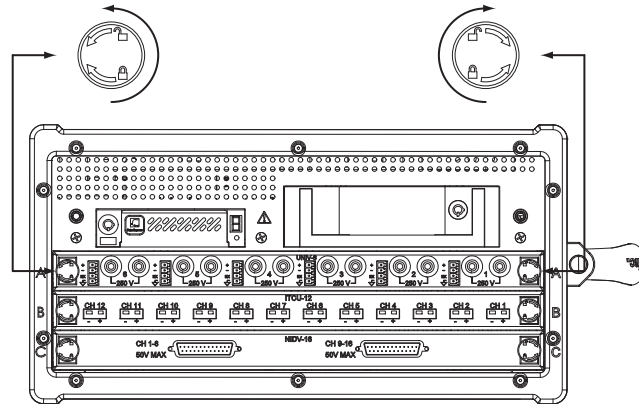

- Grasp the two knobs and slide the input module out of the recorder.

UNIV-6 - Universal voltage module with DC bridge

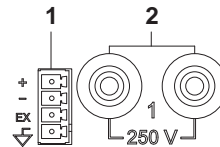
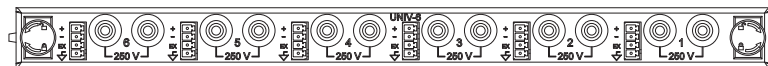

#	Description
1	Differential / DC bridge input
2	Single ended input

Warning: You must only use one physical connection per channel at a time. Use either the 4-pin connector or the banana jack inputs.

UNIV-6 Single ended inputs

Use the following diagram to connect to the single ended inputs.

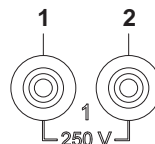

#	Description
1	Black (-) input
2	Red (+) input

Note: The use of guarded banana test leads will eliminate the possibility of introducing a ground to the equipment under test if a regular banana test lead should come in contact with the recorder metal case.

UNIV-6 Differential / DC bridge inputs

Use the following diagram to connect to the differential / DC bridge inputs.

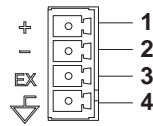

#	Description
1	Differential input (+)
2	Differential input (-)
3	Excitation output (0 to 10V DC, 30 mA max)
4	Excitation return (ISOCOM)

UNIV-6 DC bridge wiring diagrams

Use the following diagrams to set up DC bridge wiring on the four-pin connector on the UNIV-6.

Four-wire full bridge

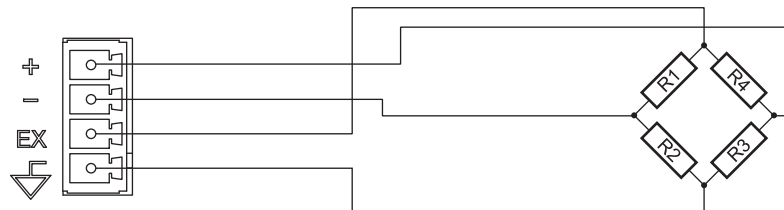

Three-wire half bridge

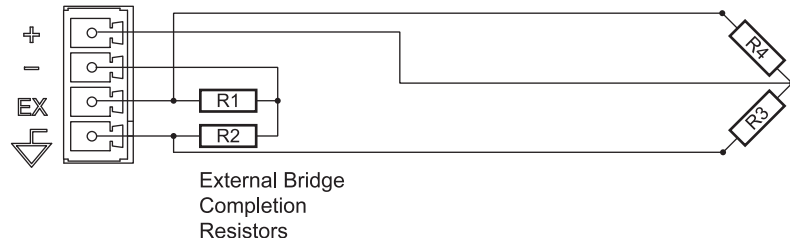

Three-wire quarter bridge

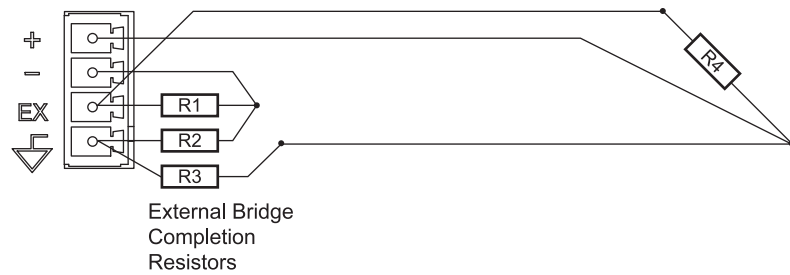

Two-wire quarter bridge

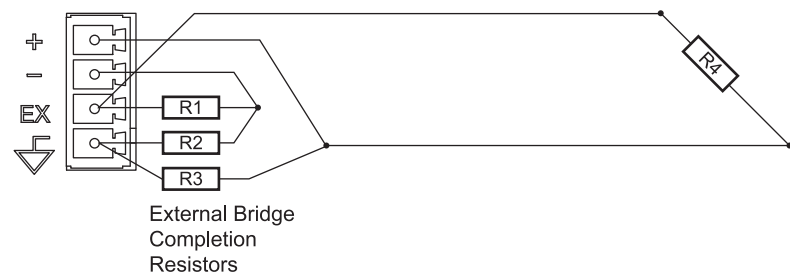

NIDV-16 - Non-isolated differential voltage module

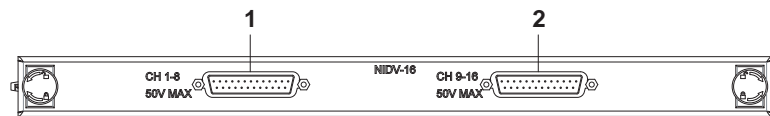

#	Description
1	Channels 1 - 8
2	Channels 9 - 16

NIDV-16 Differential inputs

Use the following diagram to connect to the differential signal inputs. A 25-pin male D-shell connector is used for analog inputs. All signal grounds on the analog input connector are tied together.

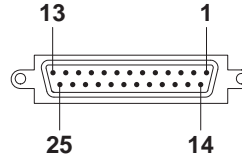

Use the following wiring configuration table to connect NIDV-16 differential inputs.

Pin #	Signal Inputs	
	Channels 1 - 8	Channels 9 - 16
1	Channel 1 (+)	Channel 9 (+)
2	Channel 1 (-)	Channel 9 (-)
3	Ground	Ground
4	Channel 2 (+)	Channel 10 (+)
5	Channel 2 (-)	Channel 10 (-)
6	Ground	Ground
7	Channel 3 (+)	Channel 11 (+)
8	Channel 3 (-)	Channel 11 (-)
9	Ground	Ground
10	Channel 4 (+)	Channel 12 (+)
11	Channel 4 (-)	Channel 12 (-)
12	Ground	Ground
13	Channel 5 (+)	Channel 13 (+)
14	Channel 5 (-)	Channel 13 (-)
15	Ground	Ground
16	Channel 6 (+)	Channel 14 (+)
17	Channel 6 (-)	Channel 14 (-)

Pin #	Signal Inputs	
	Channels 1 - 8	Channels 9 - 16
18	Ground	Ground
19	Channel 7 (+)	Channel 15 (+)
20	Channel 7 (-)	Channel 15 (-)
21	Ground	Ground
22	Channel 8 (+)	Channel 16 (+)
23	Channel 8 (-)	Channel 16 (-)
24	Ground	Ground
25	12V @ 200 mA max	12V @ 200 mA max

IHVM-6 - Isolated high voltage differential input module

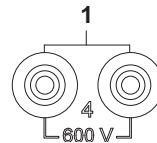
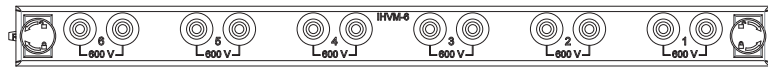

#	Description
1	Differential input

IHVM-6 Differential inputs

Use the following diagram to connect to the differential inputs.

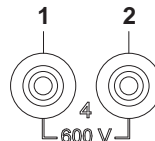

#	Description
1	Black (-) input
2	Red (+) input

Note: The use of guarded banana test leads will eliminate the possibility of introducing a ground to the equipment under test if a regular banana test lead should come in contact with the recorder metal case.

ITCU-12 Universal thermocouple amplifier

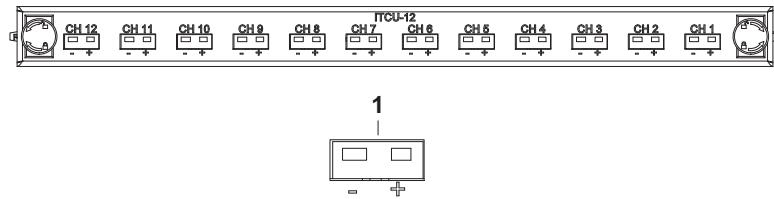

#	Description
1	Type U miniature thermocouple input

ITCU-12 Temperature ranges

The following list describes temperature measurement ranges based on thermocouple type.

Type	Range
Specified Range Type J:	-210 to 1200 °C
Specified Range Type K:	-200 to 1372 °C
Specified Range Type E:	-200 to 1000 °C
Specified Range Type T:	-200 to 400 °C
Specified Range Type N:	-200 to 1300 °C
Specified Range Type B:	600 to 1820 °C (250 to 1820 on menu)
Specified Range Type R:	0 to 1767 °C (-20 to 1768 on menu)
Specified Range Type S:	0 to 1767 °C (-20 to 1768 on menu)
Specified Range Type C:	0 to 2316 °C

Thermocouple application notes

The following table provides background information about each thermocouple type.

Note: *This information is intended primarily as an overview. For a more detailed explanation of thermocouple types and applications, refer to one of the many texts available on the subject of thermocouples.*

Type	Description
J	This type is a popular thermocouple for general use. However, this type can rust in oxidizing environments and sub-zero temperatures.
K	This type is a popular thermocouple recommended for use in oxidizing environments.
E	This type has the highest voltage output of standard thermocouple types and does not corrode at sub-zero temperatures.
T	This type is often used in moist or sub-zero temperature environments. It provides excellent corrosion resistance.
N	This type is a newer, general purpose type which offers higher stability than standard types such as J, K, E, or T.
B	This type is used in high temperature environments. However, this type can be contaminated easily.
R	This type is a Japanese standard, often used in high temperature, oxidizing environments. However, this type can be contaminated easily.
S	This type is an international lab standard and resists oxidation and corrosion. However, this type can be contaminated easily.
C	This type is used at extremely high temperatures. However, this type has no oxidation resistance.

Thermocouple composition

The following table describes the composition based on thermocouple type.

Type	Composition
J	Fe versus Cu-Ni alloy
K	Ni-Cr alloy versus Ni-Al alloy

Type	Composition
E	Ni-Cr alloy versus Cu-Ni alloy
T	Cu versus Cu-Ni alloy
N	Ni-Cr-Si alloy versus Ni-Si-Mg alloy
B	Pt-30% Rh versus Pt-6% Rh
R	Pt-13% Rh versus Pt
S	Pt-10% Rh versus Pt
C	W-5% Re versus W-26% Re

Thermocouple wire coloring standards

The following table describes the ANSI and IEC wire color standards based on thermocouple type.

Type	ANSI Wire Color Standard		IEC Wire Color Standard	
	Positive	Negative	Positive	Negative
J	White	Red	Black	White
K	Yellow	Red	Green	White
E	Purple	Red	Violet	White
T	Blue	Red	Brown	White
N	Orange	Red	Pink	White
B	Gray	Red	-	White
R	Black	Red	Orange	White
S	Black	Red	Orange	White
C	White	Red	No standard	

4

Optional hardware

Installing a mouse and keyboard

The mouse and keyboard provide an additional method for controlling the recorder. The touch-screen will remain active, regardless of whether a mouse and keyboard are installed.

- 1 Turn the power off on the recorder.
- 2 Connect a mouse and/or keyboard to the recorder via the inputs on the side panel. The recorder provides built-in support for a variety of standard PS2 and USB mice and keyboards. Installing drivers is not necessary.
- 3 Turn the recorder power on.
- 4 Use the mouse and keyboard.
 - The mouse can be used as a pointing and selection device.
 - The keyboard can be used as an alphanumeric input device while a keypad or number pad is visible on the display.

USB memory devices

You can install a USB hard drive or flash drive using an available USB port on the recorder. USB memory devices can be used for a variety of purposes, including the following:

- Saving and loading setup files
- Saving archived data captures and scope captures
- Upgrading the system software

Installing the USB external hard drive (EHD-USB)

- 1 Turn the power off on the recorder.
- 2 Connect the EHD-USB to the recorder via the USB port.
- 3 Turn the EHD-USB power on.
- 4 Turn the recorder power on. The EHD-USB will be assigned a drive letter.

Installing the USB flash memory drive

- 1 Connect the drive to the recorder via the USB port.
- 2 The drive will be assigned a drive letter.

External monitor

An external monitor can be connected to the recorder via the VGA port. When installed, the monitor will display the contents of the recorder touch-screen.

Note: *Ensure that the monitor is capable of displaying a 1280 x 1024 screen resolution.*

Installing an external monitor using the touch-screen

- 1 Turn the power off on the recorder. Then connect the external monitor to the VGA port located on the side of the recorder.
- 2 Turn the recorder power on.
- 3 Choose Configuration >> Utilities from the menu bar to open the utilities screen.

From the Utilities screen, choose the Operating System button. The Enter Password window will open.

Enter the system password and choose OK. The TMX software will shut down, providing access to the operating system.

Note: *The default system password is “tmx” (lowercase, without the quotation marks).*

- 4 Choose Start >> Control Panel to open the Control Panel window.

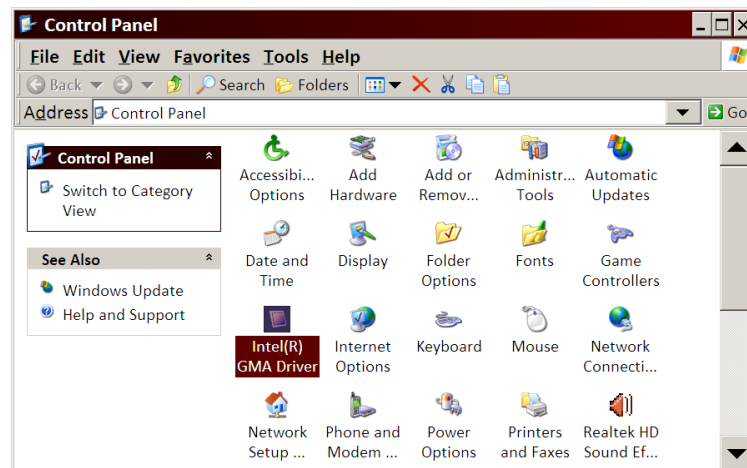

- 5 Double-click the Intel GMA Driver option. The Intel Graphics Media Accelerator Driver window will open.

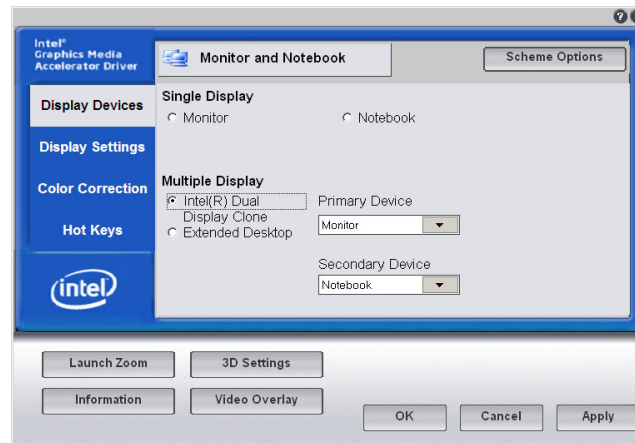

In this window, “monitor” refers to the external display and “notebook” refers to the recorder touch-screen.

- 6 Choose the Intel Dual Display Clone option. Then choose Apply. The contents of the touch-screen will be displayed on the external monitor. A confirmation message will appear.

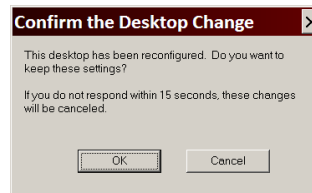

Choose OK to confirm the change.

- 7 Choose OK in the Intel Graphics Media Accelerator Driver window. Then close the Control Panel window.

Related Topics:

- *Changing passwords on page 190*

Installing an external monitor using a mouse

- 1 Turn the power off on the recorder. Then connect the external monitor to the VGA port located on the side of the recorder.
- 2 Connect a mouse to the mouse port on the side of the recorder.
- 3 Turn the recorder power on.
- 4 Choose Configuration >> Utilities from the menu bar to open the utilities screen.

From the Utilities screen, choose the Operating System button. The Enter Password window will open.

Enter the system password and choose OK. The TMX software will shut down, providing access to the operating system.

Note: The default system password is “tmx” (lowercase, without the quotation marks).

- 5 Right-click the desktop. A menu will appear.

Choose Graphics Options >> Output To >> Intel(R) Dual Display Clone >> Monitor + Notebook.

In this menu, “monitor” refers to the external display and “notebook” refers to the recorder touch-screen.

Related Topics:
- *Changing passwords on page 190*

Installing Windows-based printers

Windows-based printers are supported via USB port or network connection. Windows-based printers can be used to print screen captures.

Note: Using a Windows-based printer may affect real-time displays, and some printers will perform better than others. Astro-Med will not guarantee full specifications while a Windows-based printer is printing.

Many printer drivers are pre-installed as part of the operating system. If the necessary drivers are not pre-installed, they need to be made available to the recorder. A USB-based memory storage device can facilitate this process.

- 1 Turn the recorder power on.
 - If you are installing a USB-based printer, connect the printer to the recorder using a USB cable.
 - If you are installing a network-based printer, connect the recorder to the network using a network cable.
- 2 Choose Configuration >> Utilities from the menu bar to open the utilities screen.

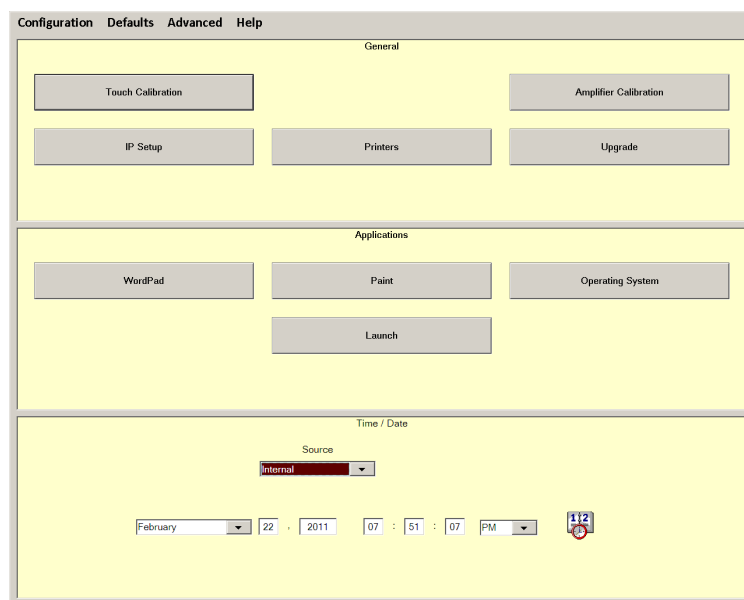

- 3 Choose the Printers button. The Printers and Faxes window will open. This window is a part of the Windows operating system.

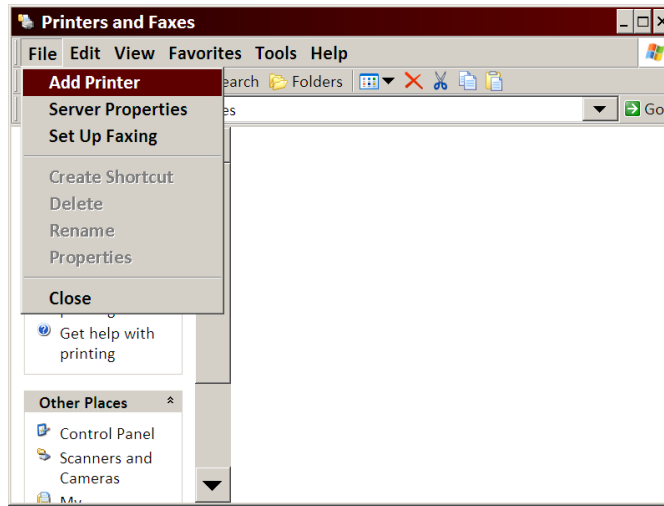

- 4 Choose File >> Add Printer. The printer installation wizard will start.
- 5 Follow the printer wizard instructions to install the printer.

If the operating system does not include the necessary printer driver, obtain the driver and copy it to a USB-based memory storage device. Then connect the storage device to the recorder via a USB port. When prompted by Windows to search for drivers, browse to the driver located on the USB storage device.

TMX-E

The TMX-E is an optional expansion chassis that allows you to connect three additional input modules to your TMX system.

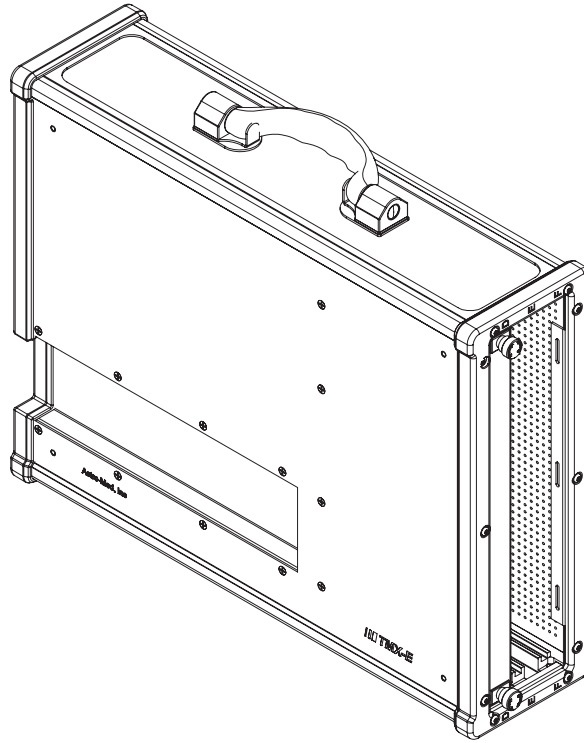

TMX-E input module locations

The TMX-E adds up to three modules for signal input connections. Input modules can be installed using the plug-in slots located on the side of the TMX-E. The slots are labeled D, E, and F for module identification in the software.

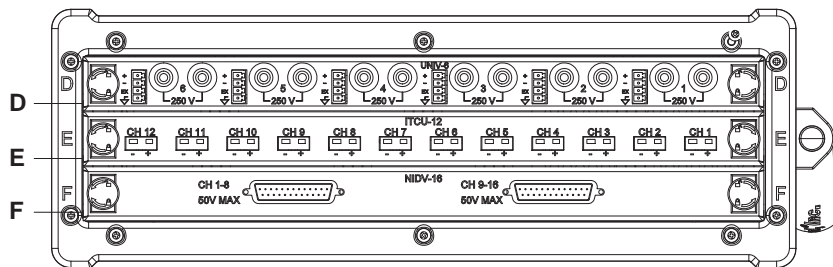

Note: The input modules displayed in this diagram are used for illustration purposes. The appearance of input modules will vary based on the module types installed.

Related Topics:
 - *Input modules on page 23*

Installing the TMX-E

After installing the TMX-E and powering up the TMX-E and TMX recorder, the additional input modules will be recognized by the system.

- 1 Turn the power off on the recorder.
- 2 Install the appropriate input modules in the TMX-E. This process is identical to installing input modules in the TMX recorder.
- 3 Refer to the following illustration as you install the TMX-E.

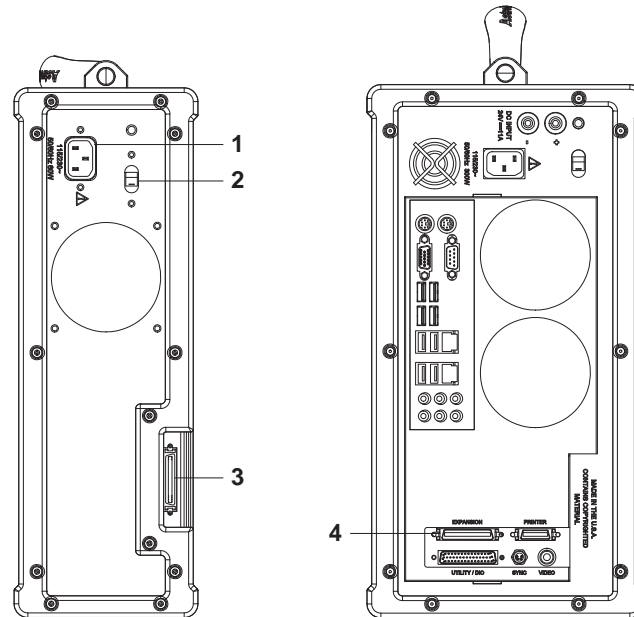

- 4 Connect power to the TMX-E via the supplied power cable and the TMX-E power inlet (1).
- 5 Use the 50-pin cable to connect the TMX-E port (3) to the TMX expansion port (4)
- 6 Use the TMX-E power switch (2) to turn the TMX-E power on.
- 7 Turn the recorder power on.

Related Topics:

- *Input modules on page 23*

Real-Chart NP printer

The Real-Chart NP is a powerful strip chart printing platform. It is an ideal printer for applications such as flight testing, missile testing, flight simulation, and satellite telemetry.

You can connect the TMX to a Real-Chart NP via Ethernet and print waveform data in Scope, Realtime, and Review modes.

To print with the Real-Chart NP, you must be using TMX system software version 1.2 or higher.

Connecting the TMX and Real-Chart NP

Use the following instructions to connect the Real-Chart NP and TMX via Ethernet.

This procedure assumes you have configured an IP address for the Real-Chart NP. Refer to the Real-Chart NP Operations Manual for details. It also assumes you have configured an IP address for the TMX. Make note of the IP setup details for later use.

- 1** Ensure the TMX and Real-Chart NP are powered off. Also ensure that paper is loaded in the Real-Chart NP. Refer to the Real-Chart NP Operations Manual.
- 2** Connect the TMX and Real-Chart NP via Ethernet. When connecting to the TMX, use the Ethernet port indicated in the following illustration.

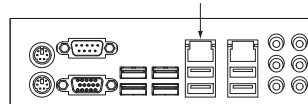

- For a direct connection, use an Ethernet crossover cable. Connect one end to the Real-Chart NP Ethernet port. Connect the other end to the indicated Ethernet port on the TMX.
 - For connection through a network, use standard Ethernet cables. Connect the Real-Chart NP Ethernet port and the indicated Ethernet port on the TMX to your network.
- 3** Turn on the TMX and Real-Chart NP.

Related Topics:

- *Installing a mouse and keyboard on page 33*
- *Left side view on page 8*
- *Modifying IP information on page 177*

Printing with the Real-Chart NP

Use the Real-Chart window to configure the printed chart. The view on the display is independent of the print settings in the Real-Chart window.

Note: The maximum speed is 10 mm/s when the Real-Chart NP is used.

- 1 Choose Chart >> Setup. The Real-Chart window will open. The appearance of this window will vary based on the current mode (Scope, Realtime, or Review).

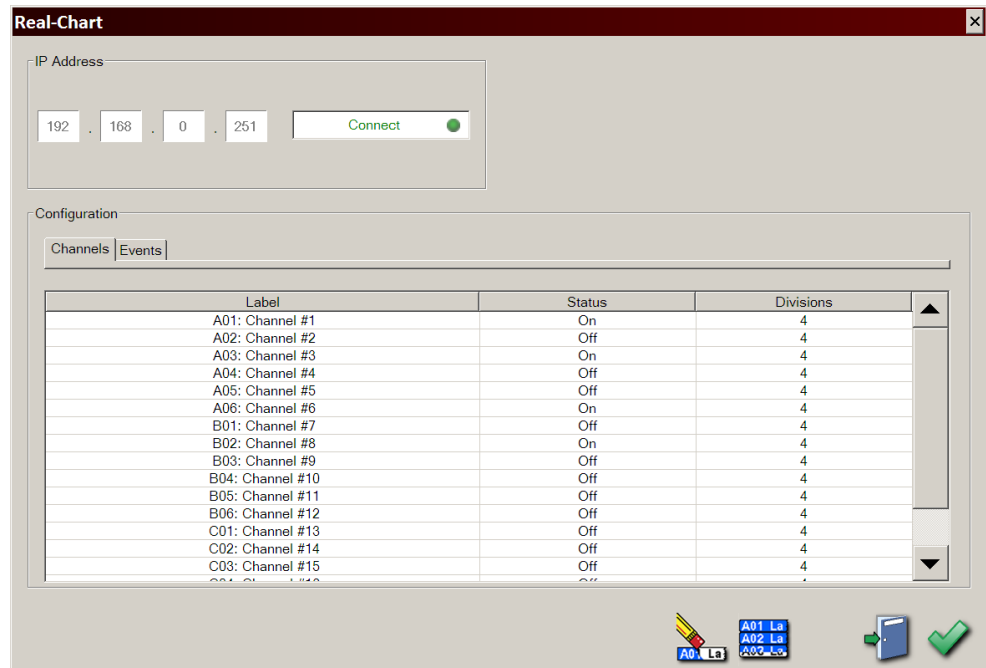

- 2 Enter the IP address of the Real-Chart NP. Then choose Connect.

A green indicator will appear in the Connect button to indicate a successful connection.

- 3 Enable printing for channels and events.
 - To enable printing for a channel, select the channel and choose the Status column heading. Select On. You can also specify the number of divisions to use on the printed chart with the Divisions column heading.
 - To enable printing for an event, select the event and choose the Status column heading. Select On.
- 4 Enable the desired playback options (Scope and Review modes only). This step does not apply to Realtime mode.

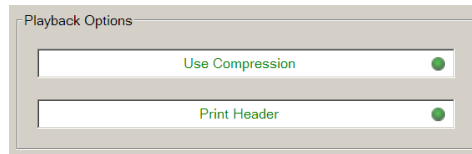

- **Use Compression** - Choose this option to print using the compression settings currently configured in Review mode. This option is only available in Review mode.
 - **Print Header** - Choose this option to print information related to the capture at the start of playback. The header contains scaling information for each channel. This option is available in Scope and Review modes.
- 5 Choose OK.
 - 6 Print with the Real-Chart NP.
 - In Scope or Review mode, choose Chart >> Playback. Select whether to print the entire file, current page, or the area between cursors. The Chart Playback window will indicate the printing progress.

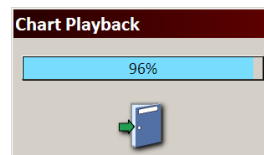

You can stop printing by choosing the Exit icon in the Chart Playback window.

- In Realtime mode, choose Chart >> Run/Halt to start and stop the printed chart.

Related Topics:
 - *Connecting the TMX and Real-Chart NP on page 40*

TMX-IRIG/GPS

By default, the TMX uses an internal time reference. In some cases, an external time reference may be needed. The TMX-IRIG/GPS is a purchased option for the TMX that

allows the use of external time references. The TMX-IRIG/GPS card is installed in a slot on the left side of the recorder.

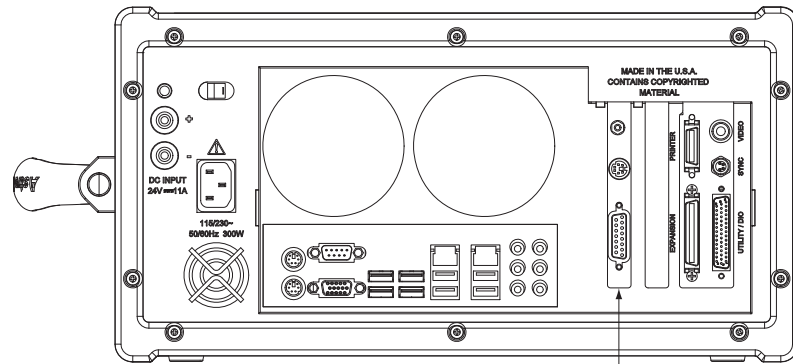

An external reference is a time code supplied by the user in either IRIG, NASA, or GPS format. If an external time source is referenced, the recorder's time functions are synchronized to it.

For example, when viewing time-based measurements in the Channel Information window or Absolute Time in the Review mode status text, the external time will be displayed instead of the system-based time.

The following external time options are available:

- IRIG A
- IRIG B
- IRIG G
- IRIG E
- NASA 36
- GPS

Connecting a time source with the TMX-IRIG/GPS option

- 1 Connect the supplied IRIG harness from the Utility / DIO port to the Timing I/O port on the TMX-IRIG/GPS card.

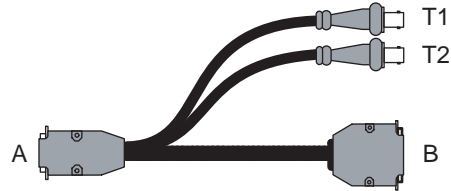
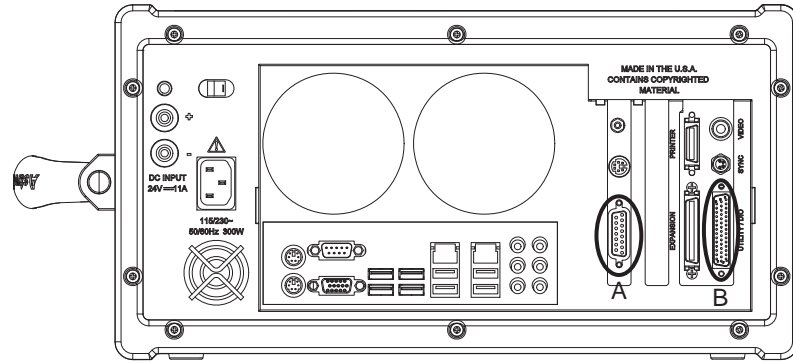

Note: This harness uses specific Utility / DIO inputs for IRIG timing. For information about accessing unused Utility / DIO ports, contact Technical Support.

- 2 Connect the time source using one of the following methods.
 - If you are using an amplitude modulated time code, connect to the BNC input labeled **T1** on the IRIG harness.
 - If you are using a DC signal level time code, connect to the BNC input labeled **T2** on the IRIG harness.
 - If you are using a GPS time code, connect the supplied antenna adapter harness to the GPS Antenna port on the TMX-IRIG/GPS card. Then connect the supplied antenna cable to the adapter harness.

Related Topics:

- *Selecting and calibrating the TMX-IRIG/GPS time code on page 44*

Selecting and calibrating the TMX-IRIG/GPS time code

After selecting a time code, you must calibrate the TMX-IRIG/GPS to a known time source. This important process ensures that time specifications are met. Calibration is required any time a new time code is selected.

Once a time code is calibrated successfully, you can power the TMX off and back on again without needing to re-calibrate. However, if you change the time code selection, calibration will be required.

Note: The time code calibration process requires approximately 1 hour to complete.

- 1 Ensure you have a time source connected and supplying a signal to the TMX.
- 2 Choose Configuration >> Utilities from the menu bar to open the utilities screen.

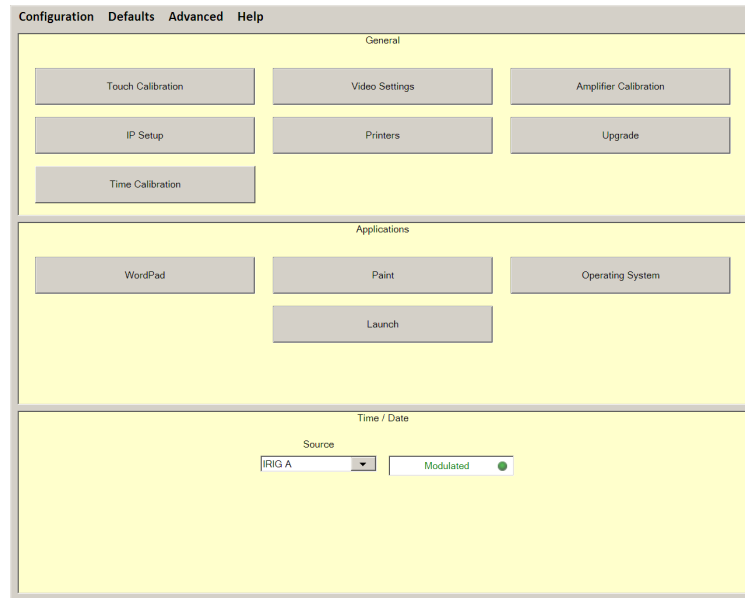

- 3 Select a time code from the source list.

If you select an IRIG or NASA time code, the Modulated option will be available. If your time code is amplitude modulated, enable this option. If your time code uses DC signal levels, leave the Modulated option disabled.

- 4 Choose the Time Calibration button. The Enter Password window will open. Enter the calibration password and choose OK.

Note: The default calibration password is “astromed” (lowercase, without the quotation marks).

The Time Calibration window will open.

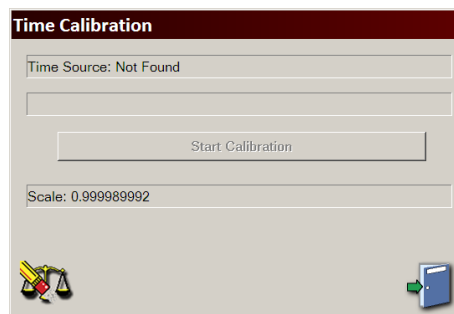

- 5 If necessary, you can clear the current time calibration settings by choosing the Clear icon.



- 6 Choose the Start Calibration button. The time code will be calibrated. This process requires approximately 1 hour to complete.

Related Topics:

- *Connecting a time source with the TMX-IRIG/GPS option on page 44*

Working with the TMX-IRIG/GPS time code

The following general notes apply to using time codes with the TMX-IRIG/GPS option.

- **Verify time decoding** - It is crucial to verify time decoding before you start recording.

The TMX-IRIG/GPS card will keep time internally based on the last time decoded. If the card is not receiving a time signal, it will still report a time, and an asterisk (*) will be displayed in the Realtime status bar near the time.

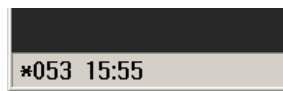

Before recording, verify that your time source is connected and supplying a signal to the TMX. Ensure that an asterisk (*) is **not** displayed with the time.

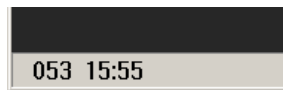

- **Modes of operation** - The time code will be used in Scope, Realtime, and Review modes.

The following illustration displays IRIG time codes in Scope mode. The IRIG time is displayed in the Channel Information window.

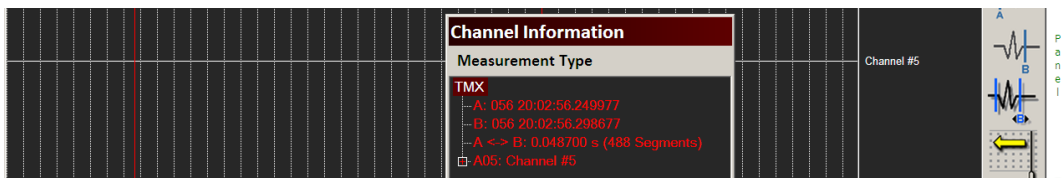

Note: IRIG time codes are also displayed in the Channel Information window for Realtime and Review modes.

The following illustration displays IRIG time codes in Realtime mode. The IRIG time is displayed in the lower-left corner of the screen in the status bar.

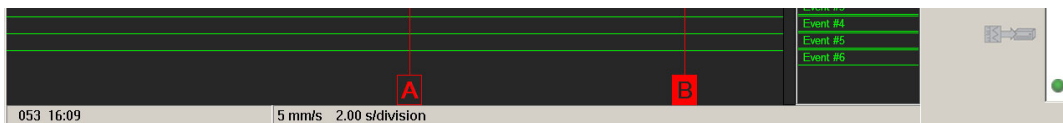

The following illustration displays IRIG time codes in the Review mode status bar. You can view IRIG time by choosing View >> Status Text Format >> Absolute Time from the menu bar in Review mode.

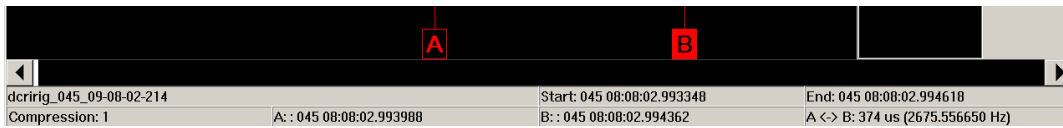

- **Data capture file name** - Data capture files will be saved with the creation time in IRIG format as part of the data capture file name.
- **Real-Chart NP printing** - If you are using the optional Real-Chart NP printer, the time code will be printed on the chart.

AstroDock TMX

The AstroDock TMX is a two-drive docking station that accepts the removable system and data capture drives from TMX series recorders. The system connects to a PC via USB.

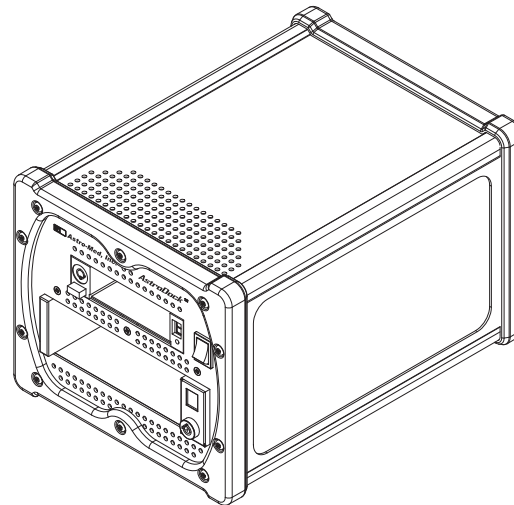

AstroVIEW X software on the PC can be used to access, review, and transfer data capture files on the installed drives.

For more information, refer to the AstroDock TMX Operations Manual.

5

Menus and icons

Menu bar

The menu bar is a group of drop-down menus located across the top of the display. All modes and features can be accessed from this menu. Menu options will vary based on the mode of operation (Realtime, Scope, or Review) used.

The following illustration displays the menu bar with the Configuration menu selected.

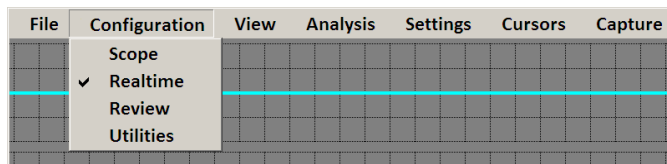

Locking the menu bar

The menu bar can be locked to prevent unauthorized users from accessing it. While locked, the menu bar cannot be used to access functions; the control panel must be used instead. The menu bar will remain locked, even if the recorder power is cycled, until it is unlocked by a user.

- 1 Choose Security >> Menu Lock. A keypad will appear. Enter the system password and choose OK. All menu options except Security and Help will be locked.

Note: The default system password is “tmx” (lowercase, without the quotation marks).



- 2 To unlock the menu bar, choose Security >> Menu Lock. A keypad will appear. Enter the system password and choose OK. All menu options will be unlocked.



Related Topics:

- *Changing passwords on page 190*

Common system icons

The following list describes the functions of common icons.

Icon	Description
	OK saves the information entered in a window and then closes the window.
	Exit cancels the action being performed in a window and closes the window without saving any changes.
	Apply saves the information modified in a window without closing the window.

Icon	Description
	<p>Select All selects/highlights all items in a list box.</p>
	<p>Clear Selection removes the selections/highlights from all items in a list box.</p>

Control panel

The control panel is a customizable group of icon buttons located on the right side of the display. It provides immediate access to virtually any function with one touch. Each mode of operation (Realtime, Scope, and Review) utilizes its own control panel.

The following illustration displays the control panel.

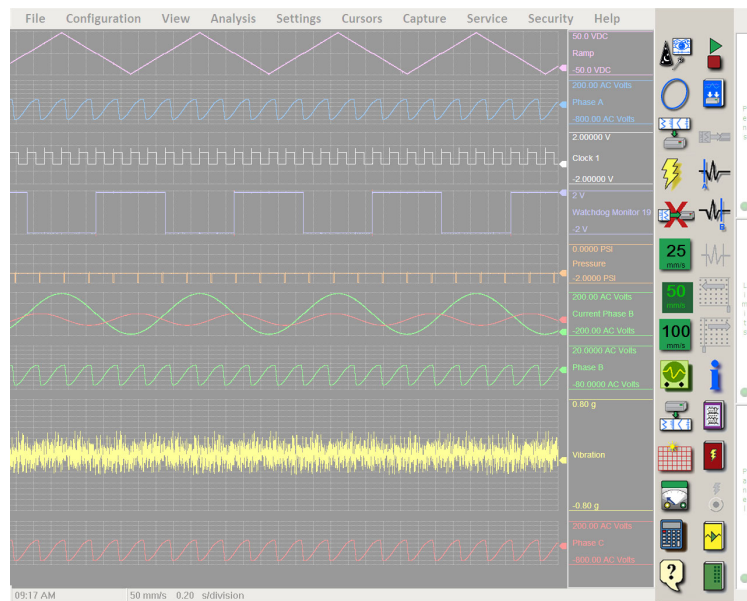

Most of the control panel buttons are one-touch equivalents of multi-step functions involving the menu bar and/or specific windows. Adding frequently used functions and removing unused functions can save time and effort while using the recorder.

For example, if the Channel Settings window is used frequently, it might be wise to add the associated icon button to the control panel. Instead of using the menu bar to choose Settings >> Channels, the function can be utilized by pressing one control panel button.

Customizing the control panel

- 1 Choose Settings >> Control Panel. The Panel Settings window will open.

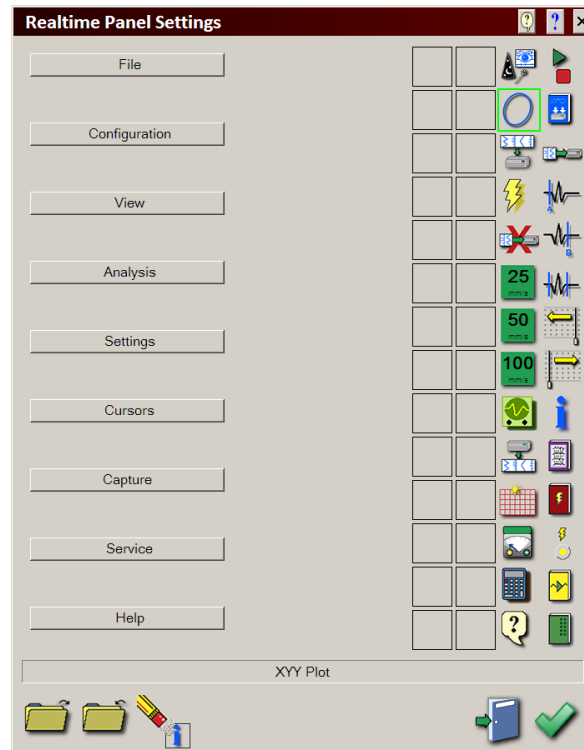

The buttons on the left provide functions that can be added to the control panel. Many of these functions correspond to menu bar options. The columns on the right display the layout of the control panel.

- 2 To add icons, select an empty control panel icon slot or existing icon. Then select a function from the buttons on the left.

An icon for the chosen function will appear in the selected control panel location. If the location previously contained an icon, the icon will be replaced.

- 3 To remove icons, select an existing control panel icon. Then choose the Clear button.



You can also remove icons by pressing and dragging an empty icon over the icon you want to remove. Release it and the icon will be removed.

- 4 To arrange the icons, select a control panel icon. While pressing the icon, drag it to a different location in the control panel and release it. The icon will be moved to the new location. If the new location previously contained an icon, it will be replaced.
- 5 Choose OK.

Control panel setup files

Control panel setup files contain information about the icons used on the control panel. Once a control panel is set up for a particular application or user, the settings can be saved to a control panel setup file for later recall. These files can greatly decrease the amount of time spent customizing control panels before measurement.

It may be helpful to create a library of control panel setup files to accommodate multiple tasks and/or users. Additionally, control panel setup files are portable, so they can be shared with other TMX units.

Saving control panel setup files

- 1 Open the Select File window using one of the following methods.
 - Choose File >> Save >> Control Panel.
 - Choose Settings >> Control Panel to open the Panel Settings window. Choose the Save Settings to File icon.



The Select File window will open.

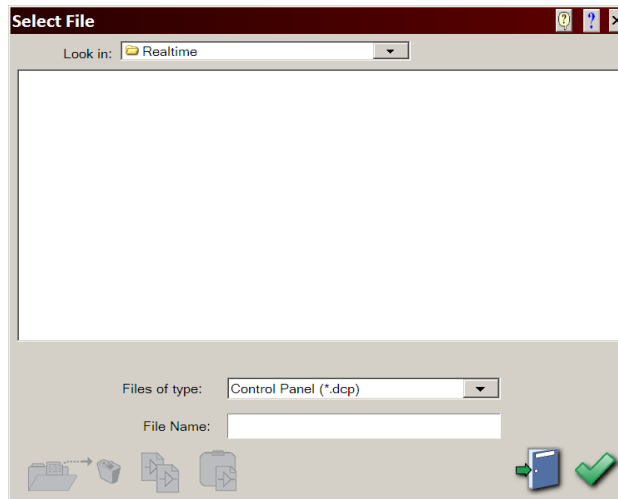

- 2 Choose a destination for the control panel setup file. By default, the file will be saved on the system drive (C) in the selected folder. If necessary, you can save the file in a different location by choosing the folder list and browsing to a folder.
- 3 Choose the File Name field. A keypad will appear. Enter a file name and choose OK. The specified file name will appear in the field.
- 4 Choose OK.

Loading control panel setup files

- 1 Open the Select File window using one of the following methods.
 - Choose File >> Load >> Control Panel.
 - Choose Settings >> Control Panel to open the Panel Settings window. Choose the Load Settings from File icon.



The Select File window will open.

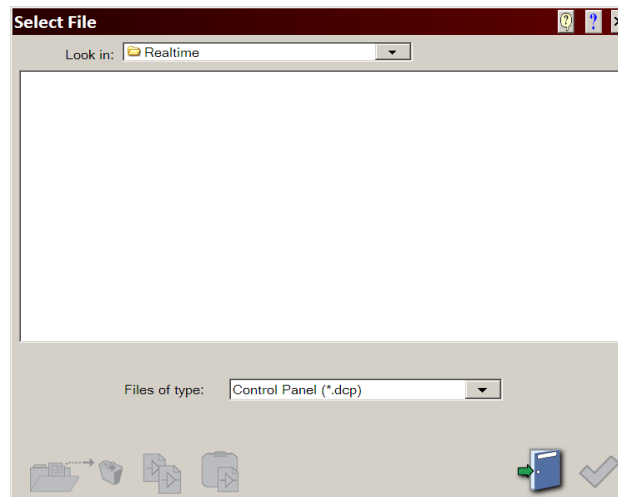

- 2 Select a control panel setup file to load. By default, files in the default location on the system drive (C) will be displayed. If necessary, you can select a file from a different location by choosing the folder list and browsing to a folder. Choose OK.

Loading control panel setup files with the control panel

You can use control panel icons to quickly load control panel setup files.

- 1 Add the control panel setup file icon to the control panel.

Choose Settings >> Control Panel to open the Panel Settings window.

Choose the File button. A sub menu will appear. Choose Control Panel. The Select File window will open.

Select a control panel setup file and choose OK. An icon for the selected file will be added to the control panel. Choose OK.



- 2 Load the control panel setup file from the control panel by choosing the appropriate control panel setup file icon.

Channel setup concepts

The following concepts are commonly used during channel setup tasks.

Channels

Channels are single paths used for displaying waveforms. A waveform displayed in a channel can be generated directly from a signal input, or can result from filtering or math operations performed on a signal input.

Signals

Signals are voltage levels transmitted to the recorder from the measurement source. Signals enter the recorder via the input modules located on the side of the unit.

Channel labels

By default, waveforms are identified by labels corresponding to channel inputs. These labels can be modified to assign meaningful names to waveforms. For example, instead of using default labels:

- A01: Channel #1
- A02: Channel #2
- A03: Channel #3

Descriptive labels can be assigned:

- A01: Power
- A02: Power (after filter)
- A03: Pressure

Spans

The span indicates the size of the channel from top edge to bottom edge.

Bottoms/Centers

The bottom option indicates the bottom point of the channel span. The center option indicates the center point of the channel span.

Engineering units

Engineering units provide the capability to display user-selected units instead of voltage.

All signal information enters the recorder as voltage. However, converting the voltage unit to an alternative unit of measure may be desirable in applications that measure pressure, strain, or any other nonvoltage unit.

Note: *The relationship between the voltage and the engineering unit is assumed to be linear, characterized by a slope and offset ($y = mx + b$).*

After engineering units are defined and enabled, all appropriate menus will be displayed in the designated engineering unit values. For example, if pounds per square inch (PSI) are used as engineering units, the PSI label and value will be displayed instead of voltage.

Low and high alarm levels

Alarms provide a visual indicator when signals extend below or above specified boundaries. These boundaries are defined by setting up low and high alarm levels.

- **Low alarm level** - An alarm will occur when a signal is at or below the specified low alarm level. Portions of the waveform in the alarm area will be drawn in the selected alarm color.
- **High alarm level** - An alarm will occur when a signal is at or above the specified high alarm level. Portions of the waveform in the alarm area will be drawn in the selected alarm color.

The utility / DIO port provides an alarm output pin that can be used to signal when alarm conditions for selected signals occur.

Filters

Filters limit waveform amplitude based on frequency and thereby restrict or allow the waveforms to pass. Filters can be set up to filter out specific ranges of frequencies while allowing others to pass through for measurement.

Anti-aliasing filter – Limits input frequencies and prevents aliasing	
Implementation	Hardware
Type	Bessel lowpass
Cutoff (-3dB)	Module specific. Refer to module specifications.
Order	4
Roll-off	-80 dB/decade

Built-in user-selectable filter – User-selectable filtering	
Implementation	Digital signal processing
Topology	IIR Biquad
Cutoff (-3dB)	User selectable
Type	Bessel Lowpass, Highpass, Bandpass, Notch
Order	2

Roll-off	-40 dB/decade
----------	---------------

Attenuators

Attenuators limit the maximum signal input to the recorder. When the attenuator ranges are unlocked, the software will select the best attenuator setting. When the attenuator ranges are locked, possible span values will be limited based on the attenuator setting.

Grounding

A ground is generally considered an equipotential point or structure designed so the voltage between any two points is zero. In practice, there are no perfect grounds and all should be considered suspect.

Grounds may be used to:

- Provide a safe return for excess current under fault conditions.
- Shield components from external sources.
- Provide a reference for voltage measurements. Poor grounding is a common cause of measurement errors.

A review of one of the many texts on the subject of grounding is advised. The following definitions are used in this document:

- **Earth Ground** is a low-impedance path to earth. In a properly installed 120-VAC outlet, the green wire is assumed to be earth ground.
- **Case Ground** refers to grounding achieved using an instrument's metal enclosure or frame. When the instrument is powered by line voltage, case ground is connected to earth ground by the power cord. When the unit is powered by external DC power, the case must be connected to earth ground by other means.
- **Signal Ground** is an analog reference point for the measuring device.
- **Source Common** is a reference point at the voltage source.

Signal inputs

The term input refers to a signal connected to a physical input on the side of the recorder. The following diagram illustrates the layout of signal inputs.

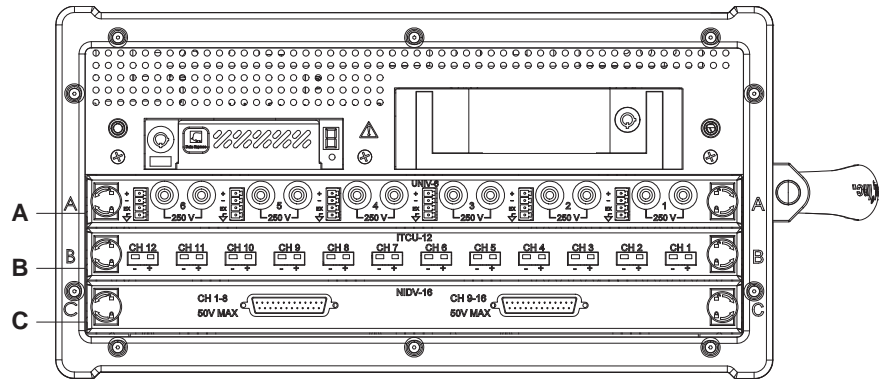

Note: The input modules displayed in this diagram are used for illustration purposes. The appearance of input modules will vary based on the module types installed.

In the software, each signal input has a channel label for identification purposes. The input label corresponds to the physical location of the input. For example, "A-01: Channel #1" is the default input label of the signal connected to channel 1 of input module A.

Channel Settings window overview

The Channel Settings window (Settings >> Channels) is used to set up channels and events. The Channel Settings window provides two layout options.

- **List view** - You can change settings in list view by selecting a channel and choosing the column heading for the setting you want to change. Some options can be configured for a group of channels at the same time by selecting a group of

channels prior to choosing a column heading. In this case, setup information will be applied to all selected channels.

Some options must be configured for each channel individually, or in groups based on compatible channels.

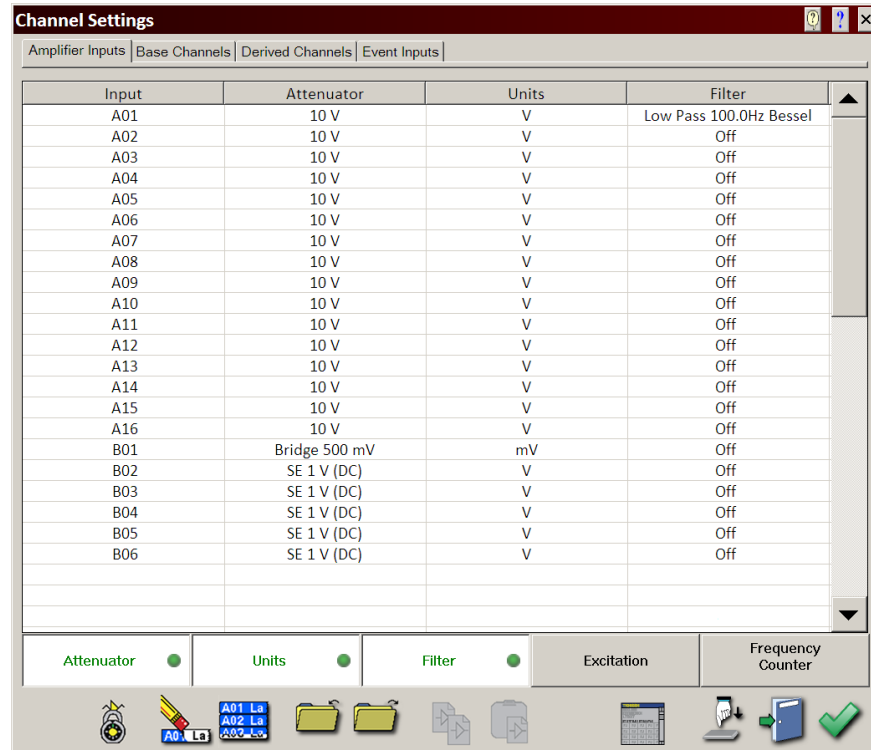

Use the buttons below the list to display other columns.

- **Graphical view** - You can change settings in graphical view by selecting a single channel and the appropriate options for the channel.

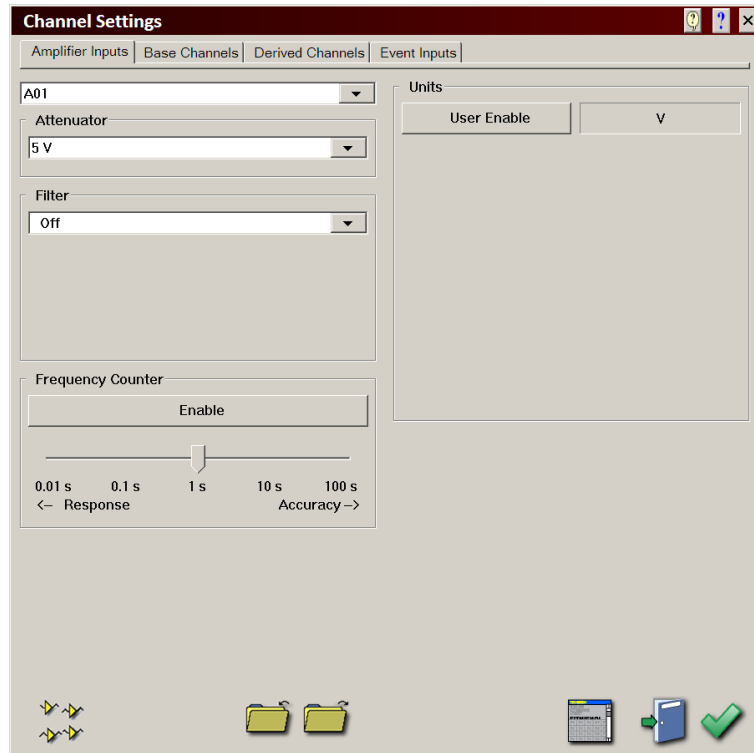

You can switch between list view and graphical view by choosing the Toggle Layout icon.



Setting up amplifier inputs

- 1 Choose Settings >> Channels. The Channel Settings window will open.

- Choose the Amplifier Inputs tab.

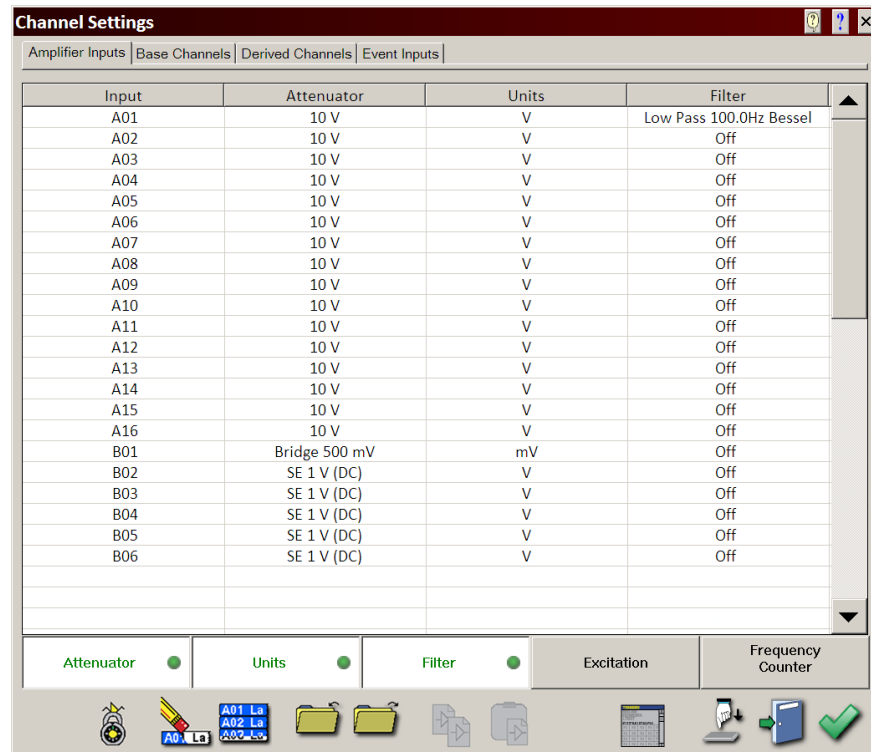

- Select an input. Inputs are labeled by module and input number. For example, "A02" indicates input number two in input module A.
- Choose the Attenuator column heading to specify the attenuator type for the input. The attenuator type refers to how the signal is physically connected to the recorder. Attenuator types vary based on input modules. The following attenuator types are available.

- Single-ended (1, 10, 50, 200, 400 V full scale)
- Differential (50, 500, 1000 mV full scale)
- Bridge (50, 500, 1000 mV full scale)

The attenuator setting limits the input signal to the selected maximum voltage.

- If necessary, enable a filter for the input.
- If necessary, set up user engineering units.
- If you are using a bridge input and attenuator, choose the Excitation column heading to select an excitation voltage for the input. This process is necessary only for bridge inputs.

- 8** Use the Attenuator Lock icon to specify whether to lock the attenuator ranges. When this button is pressed, the icon will change to indicate its current state.
- This icon indicates that the attenuator ranges **are not** locked.



- This icon indicates that the attenuator ranges **are** locked.



When the attenuator ranges are unlocked, the software will select the best attenuator setting. When the attenuator ranges are locked, possible span values will be limited based on the attenuator setting.

- 9** Choose OK.

Related Topics:

- *Setting up amplifier input filters on page 62*
- *Engineering units on page 74*

Setting up amplifier input filters

Filters are used to reduce the amplitude of certain waveforms based on their frequency. This allows you to restrict your data to certain frequencies and exclude extraneous data. Two types of filters are available.

- **Amplifier input filters** are hardware based and affect the input data before it is captured. These filters are permanent and cannot be undone once the data is captured.
- **Review mode filters** are software based and affect how the data is viewed in Review mode. They temporarily modify the view without altering the captured data.

This section describes how to set up amplifier input filters.

- 1** Choose Settings >> Channels. The Channel Settings window will open.

- 2 Choose the Amplifier Inputs tab.

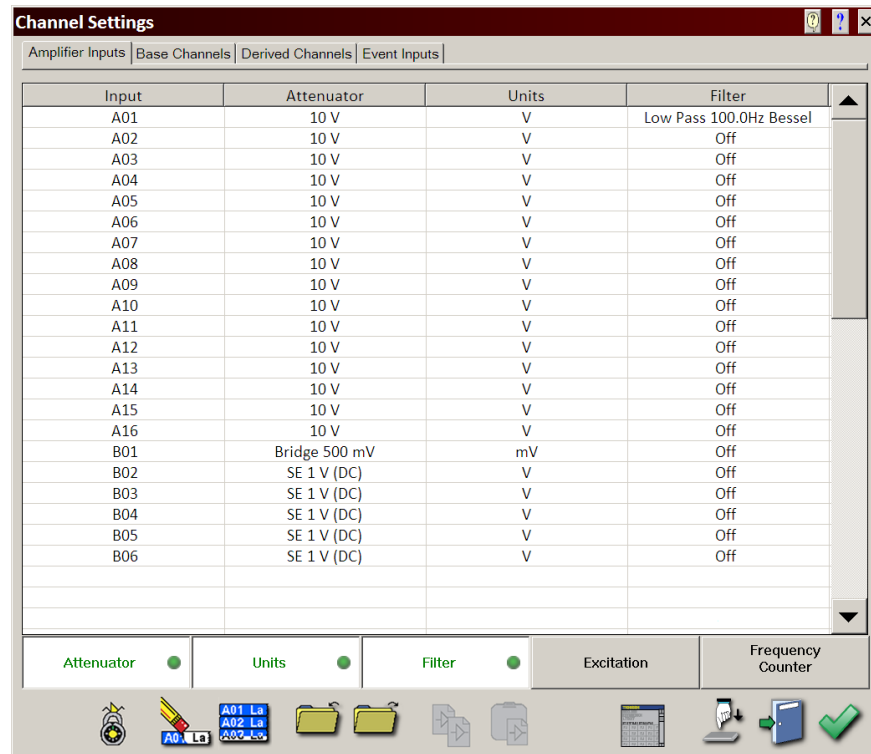

- 3 Select an input. Inputs are labeled by module and input number. For example, "A02" indicates input number two in input module A.

- 4 Choose the Filter column heading. The Filter window will open.

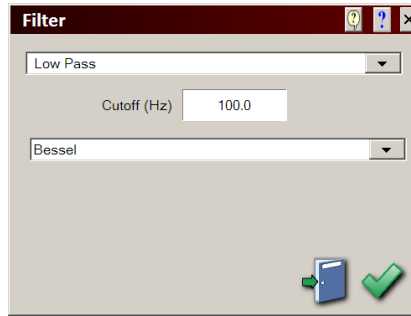

Select a filter type.

- **Low Pass** - Filters out frequencies above a specified cutoff point.
- **High Pass** - Filters out frequencies below a specified cutoff point.
- **Band Pass** - Creates a window based on two specified cutoff points, identified as upper and lower frequency boundaries. Anything outside this window is excluded.
- **Band Stop** - Creates a window based on two specified cutoff points, identified as upper and lower frequency boundaries. Anything inside this window is excluded.
- **RMS** - Filters the signal to its root-mean-square value. Because the RMS value is a measurement taken over some time period, a variety of response times are available to optimize the calculation for a particular input.

The RMS calculation is performed as follows. First the input signal is squared. The squared signal is then sent into a first order low pass filter with a cutoff frequency that corresponds to the selected response time. The square root of the filter's output is then taken to finalize the RMS calculation.

The response times are denoted by their "10-90" rise time. This is the time it takes for a square input to rise from 10% of its final value to 90% of its final value. Faster response times result in changes taking effect more quickly, but at the expense of more ripple.

Note: All filters use the 800 kHz sampling Rate.

Response Time	Cutoff Frequency
2 Seconds	0.12 Hz
.2 Seconds	1.2 Hz
.02 Seconds	12 Hz
.002 Seconds	120 Hz

Once a filter type (other than RMS) is selected, filter setup options will appear.

- 5 Select a filter topology.
 - **Bessel** filters are typically characterized by a nearly linear phase response in the pass band. They are commonly used in applications where little phase distortion is required. The trade off for this is a gentler roll off around the cutoff frequency.
 - **Butterworth** filters produce the most “ideal” response, generating maximum flatness and unity gain in the pass band, and monotonic decrease of frequency after the cutoff.
 - **Chebyshev** filters feature the sharpest transition band, but will have gain ripple in the pass band. A 4th order Chebyshev with 3 db of ripple, for instance, will drop at 100 db per decade.

If the Chebyshev topology is used, the Ripple field will appear. Enter a desired ripple value from 0.1 to 10.0 into this field.

- 6 Enter a cutoff frequency. The available range of this value will vary, depending on the current filter type. If the Band Pass or Band Stop filter types are used, you’ll need to enter two cutoff frequencies; an upper boundary and a lower boundary.

Setting a cutoff value to 500 Hz or greater will result in a 4th order filter; a cutoff of less than 500 Hz will result in a 1st order filter.

- 7 Choose OK in the Filter window.

- 8 Choose OK.

Related Topics:

- *Setting up Review mode filters on page 155*

Setting up a frequency counter

When setting up channels, a multi-purpose frequency counter will be available for some inputs, based on input module. This counter, when combined with engineering units, allows you to display units such as RPM, distance, length, shaft angle, etc. Use the following table to plan frequency counter inputs.

Frequency Counter Support	
Input Module	Input Number
UNIV-6	1
NIDV-16	1, 2
IHVM-6	1

To use the frequency counter, the input signal must transition through the counter reference threshold, which is located near the center of the grid for the UNIV-6 input module, or near zero for other input module types. Ensure your channel span and attenuator settings are configured so the signal crosses this threshold. Preferably, the

signal would be full scale on the grid for the UNIV-6 input module, or as high of an amplitude above and below zero volts for other module types.

- 1 Choose Settings >> Channels. The Channel Settings window will open.
- 2 Choose the Amplifier Inputs tab.

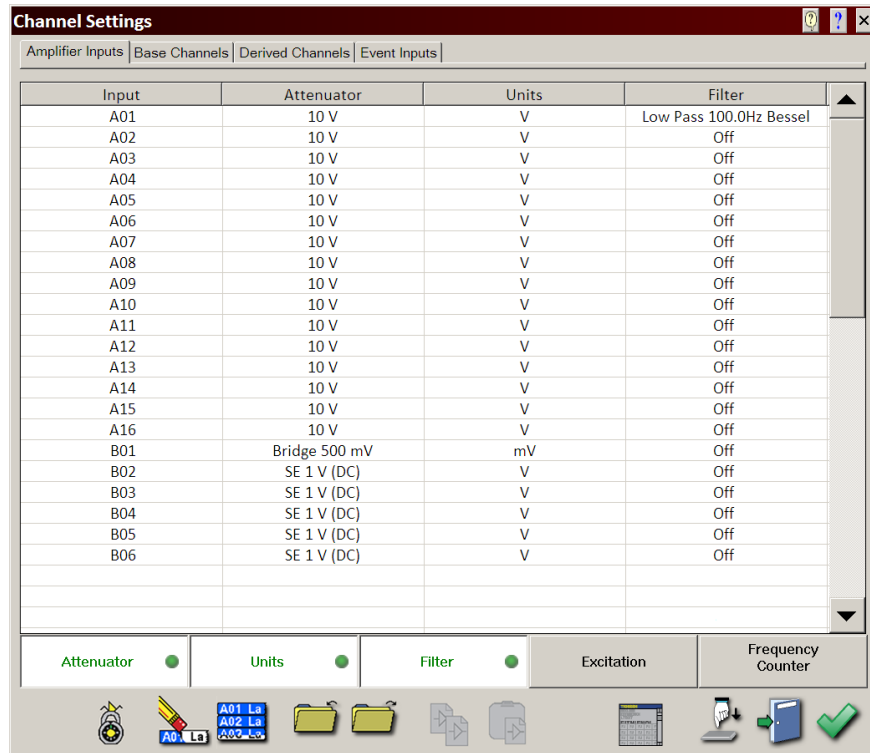

- 3 Select an input. Inputs are labeled by module and input number. For example, "A02" indicates input number two in input module A.
- 4 If you are setting up an input that supports a frequency counter, the frequency counter option will be available. Choose the Frequency Counter column heading. The Frequency Counter Settings window will open.
 - **Frequency (Time Based)** - Choose this option to use the current channel as a general purpose frequency counter. This mode has a gate time selection which is the amount of time that cycles are counted before updating the result, and thus the time over which the result is averaged. To ensure desired accuracy, this gate time must be sufficiently long as compared to the input signal's period. Use the slider to configure the gate time, moving it to the left to decrease response time, and to the right to increase accuracy.
 - **Frequency (Cycle Based)** - Choose this option to use the current channel as a frequency counter that updates as soon as possible after a new period of the input crosses through the reference threshold. This mode operates on a single period of the input signal, which must be at least 48 Hz. Response time to changes in frequency is directly proportional to the period of the input signal,

with a maximum of 43 ms, which occurs with the lowest frequency input signals. Full accuracy is retained regardless of response time.

- **Duty Cycle** - Choose this option to use the current channel as a duty cycle detector for a pulse train on the input. This counter will measure the percentage of time that the input pulse is above the counter threshold voltage.
- **Pulse Width** - Choose this option to use the current channel as a pulse width detector for a pulse train on the input. This counter will measure the amount of time (in μs) that the input pulse is above the counter threshold voltage.
- **Event Counter** - This counter mode will display the number of pulses (up to 64000000) that have been recognized since the counter was initialized. The scaling of the displayed result is determined by grid span and offset (top and bottom) settings, and an approximate count is displayed if the grid span is greater than 60000. The count can be reset to zero by re-selecting the counter type or pressing a counter reset button previously placed on the control panel.
- **Period** - Choose this option to use the current channel as a period detector for a signal on the input. This counter will measure the amount of time (in μs) between one rising edge of the input waveform and the next rising edge.
- **Quadrature Event Counter** - Choose this option to use the first two channels of a NIDV-16 input module as a quadrature (up/down) counter to count the number of pulses from a quadrature encoder. This counter uses the other counter channel as a direction input, which is usually a second pulse train that leads or lags the primary input by 90 degrees. The count can be reset to zero by re-selecting the counter type or pressing a counter reset button previously placed on the control panel.

5 Choose OK.

6 If necessary, set up engineering units to indicate units for the frequency counter channel.

Related Topics:

- *Setting up amplifier inputs on page 60*
- *Engineering units on page 74*

Automatically balancing bridge inputs

If you are using bridge inputs, you can use the bridge balance function to apply an offset to the signal to make it equal to zero.

Note: *This feature is available only if you are using the UNIV-6 input module and a “Bridge” attenuator has been selected during amplifier input setup.*

1 Choose Settings >> Channels. The Channel Settings window will open.

- 2 Choose the Amplifier Inputs tab.

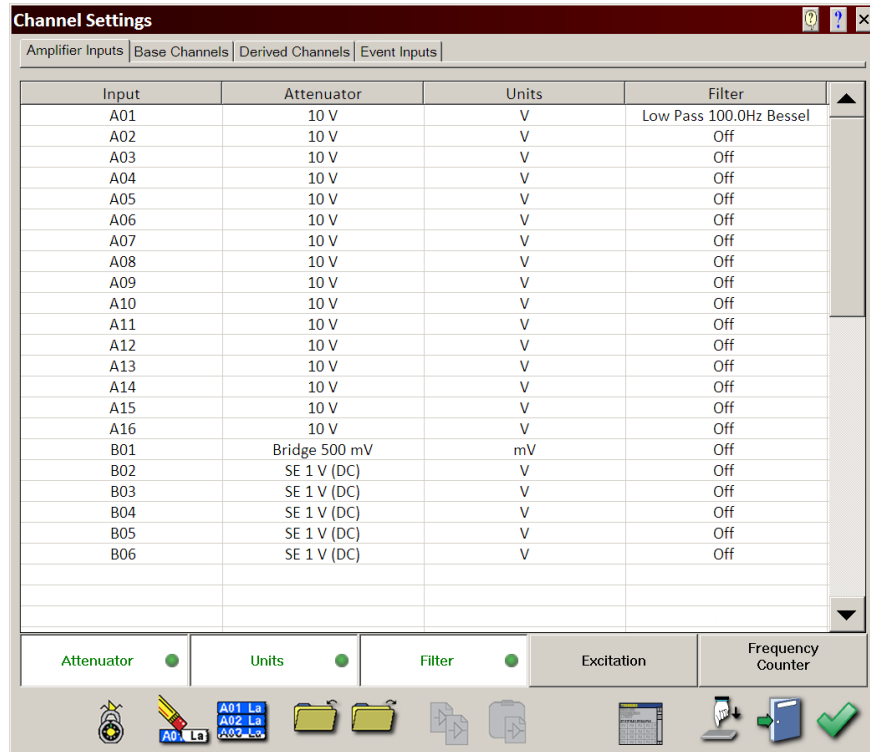

- 3 Select a channel with a “Bridge” attenuator type. The Bridge Balance feature will become available in the lower-left corner of the window.



- 4 Choose the Bridge Balance icon. The Bridge Balance window will open.

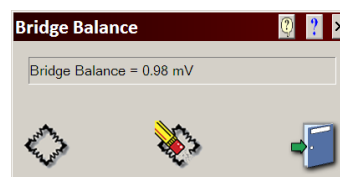

- 5 To apply a bridge balance, choose the Bridge Balance icon. The offset will be applied to make the signal equal to zero.



- 6 To clear the bridge balance, choose the Clear Bridge Balance icon. The offset will be cleared.



- 7 Choose OK.

Setting up base channels

- 1 Choose Settings >> Channels. The Channel Settings window will open.
- 2 Choose the Base Channels tab.

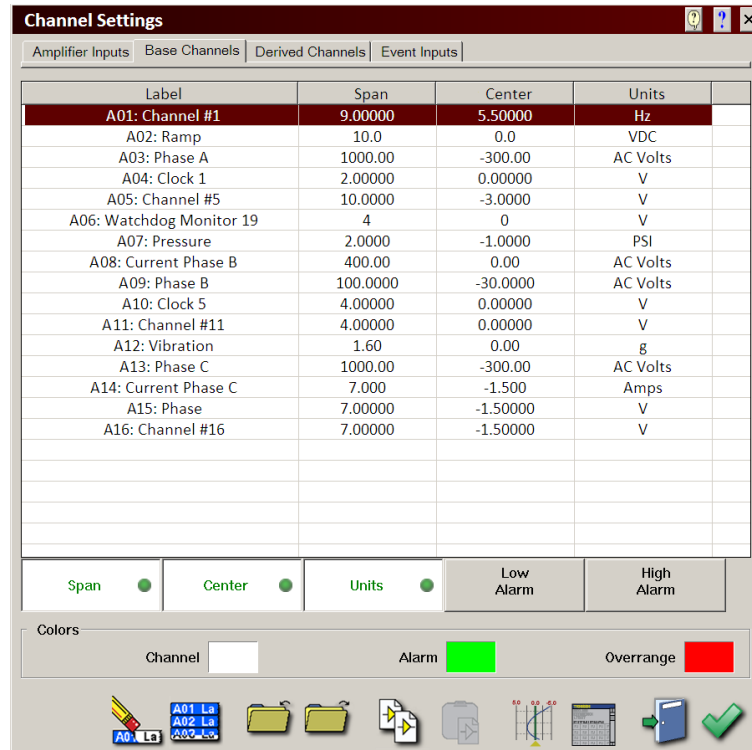

- 3 Select an input. Inputs are labeled by module and input number. For example, "A02" indicates input number two in input module A. The channel label is also visible in this list.
- 4 To edit the channel label, choose the Label column heading.

A keypad will appear. Enter a label for the channel and choose OK. The input module prefix, "A02" for example, cannot be modified.

- 5 Choose whether to define the channel in terms of top/bottom or span/center. Use the following icon to switch methods.



- **Top/Bottom** - If you select this method, choose the Top and Bottom column headings to enter the highest and lowest channel values.
 - **Span/Center** - If you select this method, choose the Span and Center column headings to enter the total span of the channel and the center value.
- 6 To use low and/or high alarms, choose the Low Alarm or High Alarm column heading. The Alarms window will open.

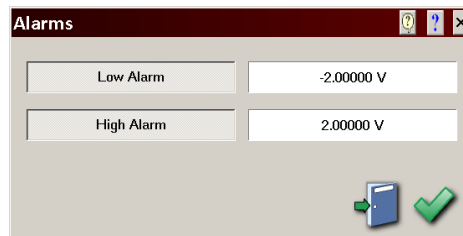

Choose the Low Alarm and/or High Alarm buttons. The selected alarms will become active and the alarm fields will be displayed. Use the alarm fields to enter alarm levels. Choose OK in the Alarms window.

- 7 Select a color scheme for the channel waveform.
 - **Channel** - This option sets the color of the waveform on the display. To modify the waveform color, choose the Channel color box. The Color window will open. Select a color and choose OK.
 - **Alarm** - This option sets the color of waveform portions that extend above or below the high and low alarm boundaries. To modify the alarm color, choose the Alarm color box. The Color window will open. Select a color and choose OK.
 - **Overrange** - This option sets the color of waveform portions that extend above or below the grid boundaries. To modify the overrange color, choose the Overrange color box. The Color window will open. Select a color and choose OK.
- 8 If necessary, set up user engineering units.
- 9 Choose OK.

Related Topics:

- *Setting up engineering units on page 75*

Derived channels

Derived channels allow you to define flows of data that are not represented by a physical input, but instead result from operations performed on data from physical inputs. Once created, derived channels can be added to any grid on the display.

Derived channel syntax

Equations are used to define the content of derived channels. The equations indicate channels and the operations to perform on the channels. Up to four channels can be included in a derived channel equation. The following table describes the syntax of derived channel equations.

Note: Units for *sin*, *cos*, and *tan* are in radians. For degrees use *sind*, *cosd*, and *tand*.

Function	Parameters	Equations
Addition	Channel1, Channel2	$A01+A02$
Subtraction	Channel1, Channel2	$A01-A02$
Multiplication	Channel1, Channel2	$A01*A02$
Division	Channel1, Channel2	$A01/A02$
Exponential	Channel1, Channel2	$A01^A02$
Sine	Channel1	$\sin(A01)$ or $\text{sind}(A01)$
Cosine	Channel1	$\cos(A01)$ or $\text{cosd}(A01)$
Tangent	Channel1	$\tan(A01)$ or $\text{tand}(A01)$
Square Root	Channel1	$\text{sqrt}(A01)$
Absolute Value	Channel1	$\text{abs}(A01)$

Note: You can also use numeric constants in the equations. For example, to multiply channel 1 by the constant 4, use the equation: $A01*4$

Parentheses must be used to denote the order of operations. Nested parentheses are allowed.

If the calculation has the possibility of a divide-by-zero error, the system will default the scaling to +/- 10,000,000 for that channel.

If an infinity calculation occurs (divide-by-zero, $\tan(90)$, etc.), the channel will be shown as overrange.

Derived channel examples

Derived channels are flexible and can be configured to suit many applications. When setting up your derived channels, consider the following:

- The purpose of the derived channel
- The label (name) you will assign to the derived channel
- The channel or channels (up to four) that will be included in the calculation of the derived channel

- The math operations that will be performed on the channel or channels

Examples are provided in the following tables for reference.

Power Calculation	
Derived Channel Purpose	Calculate power based on voltage and current input
Derived Channel Label	Power
Channels Included	A01: Voltage A05: Current
Math Operation	Multiply the voltage times the current
Derived Channel Equation	$A01 * A05$

Application-Specific Calculation	
Derived Channel Purpose	Calculate application-specific value based on voltage and a known constant
Derived Channel Label	Adjusted Voltage
Channels Included	A01: Voltage
Math Operation	Divide the voltage by the constant 2.34
Derived Channel Equation	$A01 / 2.34$

These examples illustrate only some derived channel configurations. The math functions available, up to four channel inputs, and numeric constants can be used to create a broad range of possibilities.

Setting up derived channels

- 1 Choose Settings >> Channels. The Channel Settings window will open.

2 Choose the Derived Channels tab.

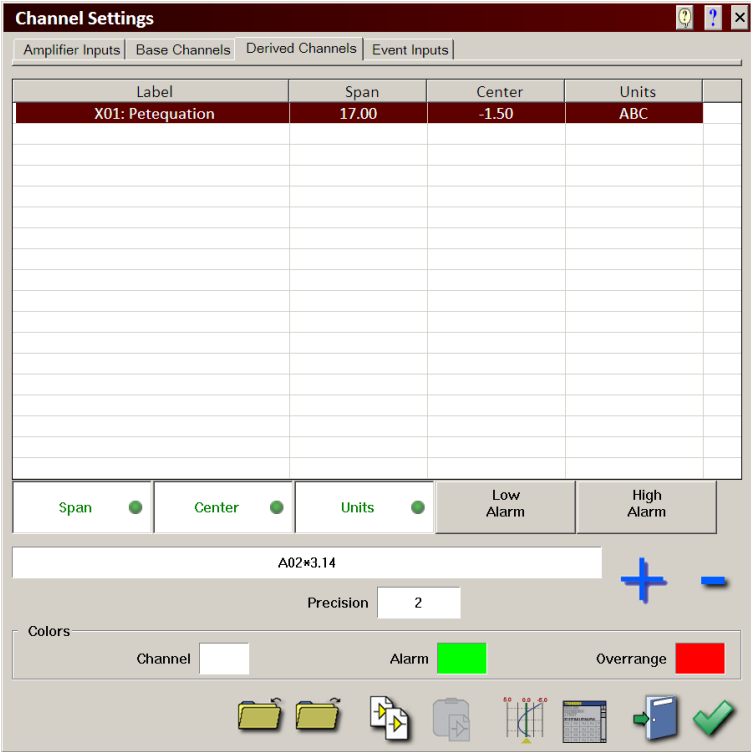

3 To add a derived channel, choose the Add icon.



A keypad will appear. Enter a label for the derived channel and choose OK. Another keypad will appear. Enter the derived channel's equation and choose OK. The derived channel will be added. If necessary, you can later edit the equation by selecting the equation field.

Note: You can remove a derived channel by selecting it from the derived channel list and choosing the Remove icon.



- 4 Choose whether to define the channel in terms of top/bottom or span/center. Use the following icon to switch methods.



- **Top/Bottom** - If you select this method, choose the Top and Bottom column headings to enter the highest and lowest channel values.
 - **Span/Center** - If you select this method, choose the Span and Center column headings to enter the total span of the channel and the center value.
- 5 To use low and/or high alarms, choose the Low Alarm or High Alarm column heading. The Alarms window will open.

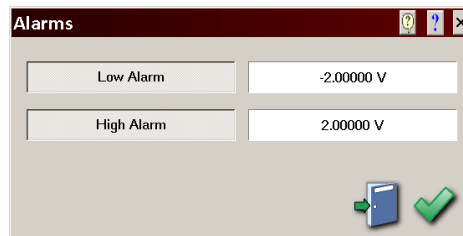

Choose the Low Alarm and/or High Alarm buttons. The selected alarms will become active and the alarm fields will be displayed. Use the alarm fields to enter alarm levels. Choose OK in the Alarms window.

- 6 Select a color scheme for the channel waveform.
 - **Channel** - This option sets the color of the waveform on the display. To modify the waveform color, choose the Channel color box. The Color window will open. Select a color and choose OK.
 - **Alarm** - This option sets the color of waveform portions that extend above or below the high and low alarm boundaries. To modify the alarm color, choose the Alarm color box. The Color window will open. Select a color and choose OK.
 - **Overrange** - This option sets the color of waveform portions that extend above or below the grid boundaries. To modify the overrange color, choose the Overrange color box. The Color window will open. Select a color and choose OK.
- 7 Choose the Units column heading to enter a name (display label) for the derived channel units.
- 8 Choose the Precision field and enter the number of decimal places for the derived channel unit. Choose OK.
- 9 Choose OK.

Engineering units

Engineering units provide the capability to display user-selected units instead of voltage.

All signal information enters the recorder as voltage. However, converting the voltage unit to an alternative unit of measure may be desirable in applications that measure pressure, strain, or any other nonvoltage unit.

Note: *The relationship between the voltage and the engineering unit is assumed to be linear, characterized by a slope and offset ($y = mx + b$).*

After engineering units are defined and enabled, all appropriate menus will be displayed in the designated engineering unit values. For example, if pounds per square inch (PSI) are used as engineering units, the PSI label and value will be displayed instead of voltage.

Setting up engineering units

- 1 Choose Settings >> Channels. The Channel Settings window will open.
- 2 Engineering units can be configured in the Amplifier Inputs and Base Channels tabs. The tab you choose depends on whether derived channels will be used.
 - **Amplifier Inputs tab** - Configure engineering units in this tab only if the channel will be used in the definition of a derived channel in the Derived Channels tab.
 - **Base Channels tab** - Configure engineering units in this tab if the channel will not be used in the definition of a derived channel.
- 3 Select an input. Inputs are labeled by module and input number. For example, "A02" indicates input number two in input module A.
- 4 Choose the Units column heading. The Units window will open. Choose the User Enable button to activate engineering units. Other engineering units options will be displayed.

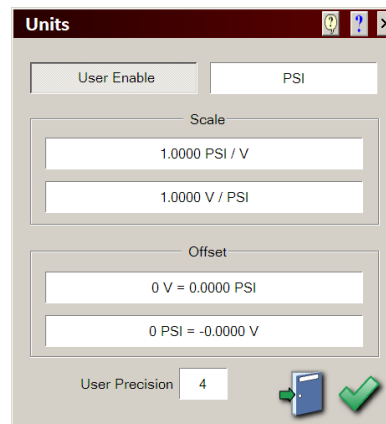

- 5 Choose the Engineering Units field and enter a name (display label) for the units. For example, PSI would be an appropriate label denoting pounds per square inch.

- 6 Enter a scale for the engineering units by choosing one of the Scale fields. A number pad will appear. Enter the scale and choose OK. Scale can be specified as either of the following:
 - The waveform change in engineering units that is equal to one voltage unit.
 - The waveform change in voltage units that is equal to one engineering unit.Only one scale entry is required; the other is derived automatically.
- 7 Enter an offset for the engineering units by choosing one of the Offset fields. A number pad will appear. Enter the offset and choose OK. Offset can be specified as either of the following:
 - The number of engineering units equivalent to zero voltage units.
 - The number of voltage units equivalent to zero engineering units.Only one offset entry is required; the other is derived automatically.
- 8 Choose the User Precision field and enter the number of decimal places for the engineering unit. Choose OK. Choose OK in the Units window.
- 9 Choose OK in the Channel Settings window.

Setting up engineering units based on DC levels

Use the following instructions to set up engineering units based on a DC signal input. With this alternative method of setting up engineering units, you do not enter the scale and offset directly. Instead, you specify high and low engineering units based on high and low signal activity.

Note: *This method of setting up engineering units is available only in Realtime mode. It does not apply to Scope mode.*

- 1 Choose Settings >> Scale to Levels. The Scale to Levels window will open.

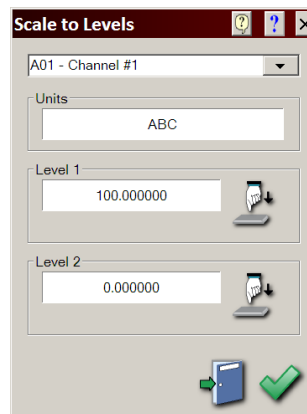

- 2 Select an input. Inputs are labeled by module and input number. For example, "A02" indicates input number two in input module A.
- 3 Choose the Units field and enter a name (display label) for the units. For example, PSI would be an appropriate label denoting pounds per square inch.

- 4 Enter low and high values for engineering units. This process assumes you know the engineering unit values associated with low and high signal levels.
 - **Level 1 (High Value)** - Adjust the signal to the level associated with the highest engineering unit value that will be used. Then choose the High Value field. A number pad will appear.

Enter the engineering unit value associated with the high signal and choose OK. Then choose the Apply button to the right of the Level 1 field. The high value will be calculated.
 - **Level 2 (Low Value)** - Adjust the signal to the level associated with the lowest engineering unit value that will be used. Then choose the Low Value field. A number pad will appear.

Enter the engineering unit value associated with the low signal and choose OK. Then choose the Apply button to the right of the Level 2 field. The low value will be calculated.
- 5 Choose OK.

Setting up event inputs

- 1 Choose Settings >> Channels. The Channel Settings window will open.
- 2 Choose the Event Inputs tab.

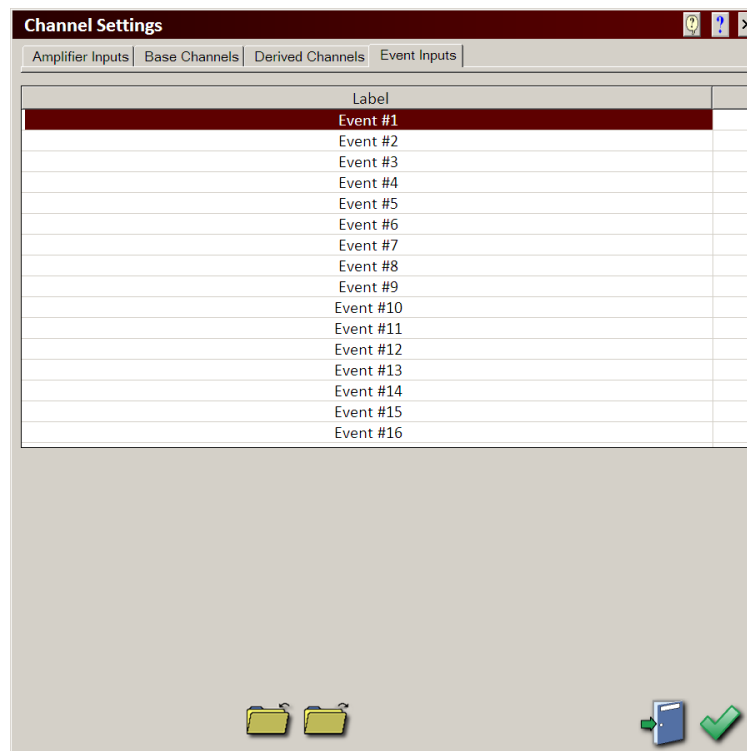

By default, events are labeled based on event input numbers.

- 3 To change an event label, select an event and choose the Label column heading. A keypad will appear. Enter an event label and choose OK.
- 4 Choose OK in the Channel Settings window.

Signal setup files

Signal setup files contain all setup information from the Channel Settings window. Once channels are set up for a particular application, the settings can be saved to a signal setup file for later recall. These files can greatly decrease the amount of time spent on setting up channels before measurement.

It may be helpful to create a library of signal setup files for commonly used measurement configurations. Additionally, signal setup files are portable, so they can be shared with other TMX units.

Saving signal setup files

- 1 Open the Select File window using one of the following methods.
 - Choose File >> Save >> Signals.
 - Choose Settings >> Channels. The Channel Settings window will open. Choose the Save Settings to File icon.



The Select File window will open.

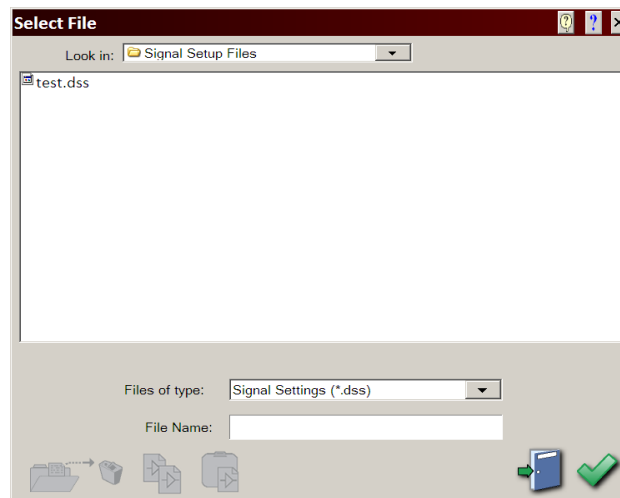

- 2 Choose a destination for the signal setup file. By default, the file will be saved on the system drive (C) in the selected folder. If necessary, you can save the file in a different location by choosing the folder list and browsing to a folder.
- 3 Choose the File Name field. A keypad will appear. Enter a file name and choose OK. The specified file name will appear in the field.
- 4 Choose OK.

Loading signal setup files

- 1 Open the Select File window using one of the following methods.
 - Choose File >> Load >> Signals.
 - Choose Settings >> Channels. The Channel Settings window will open. Choose the Load Settings from File icon.



The Select File window will open.

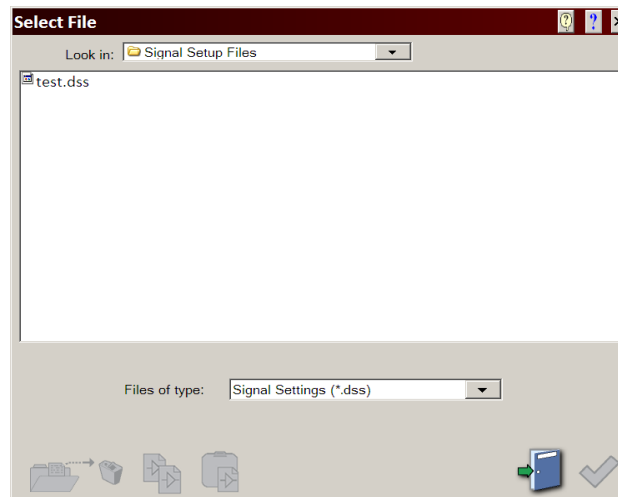

- 2 Select a signal setup file to load. By default, files in the default location on the system drive (C) will be displayed. If necessary, you can select a file from a different location by choosing the folder list and browsing to a folder. Choose OK.

Loading signal setup files with the control panel

You can use control panel icons to quickly load signal setup files.

- 1 Add the signal setup file icon to the control panel.

Choose Settings >> Control Panel to open the Panel Settings window.

Choose the File button. A sub menu will appear. Choose Signals. The Select File window will open.

Select a signal setup file and choose OK. An icon for the selected file will be added to the control panel. Choose OK.



- 2 Load the signal setup file from the control panel by choosing the appropriate signal setup file icon.

Display Wizard

Use the Display Wizard to quickly set up or modify the display. You can add, edit, and remove grids and events. When you are finished, the grids and events will be sized to fit in the waveform display area.

Using the Display Wizard

- 1 Choose View >> Wizard. The Display Wizard window will open.

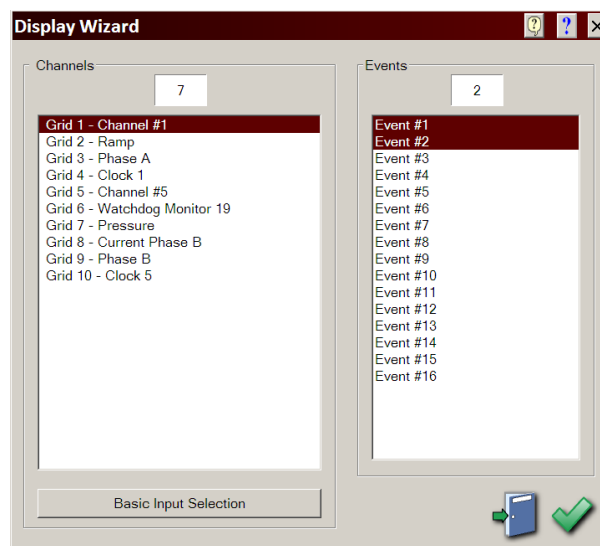

- 2 Select the channels to display by choosing them from the Channels list box.

For an alternative method of selecting channels, choose the Channels number field. A number pad will appear. Enter the number of channels to display and choose OK. The specified number of channels will be selected from the Channels list box, starting at the first channel.

You can also use the Basic Input Selection icon to quickly define a grid for each channel in an input module.

- 3 Select the events to display by choosing them from the Event list box.

For an alternative method of selecting events, choose the Events number field. A number pad will appear. Enter the number of events to display and choose OK. The specified number of events will be selected from the Events list box, starting at the first event.

- 4 Choose OK.

Grids

Channel waveforms are drawn on the display in customizable grids. The grids provide a visual aid that can be used for measurement purposes.

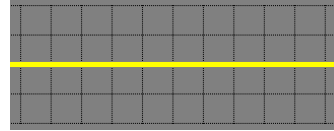

You can customize grid size, location, number of divisions, color, channel content, and various other settings to fit the needs of your application.

Adding grids

- 1 Choose View >> Add Grid. The Grid Properties window will open.

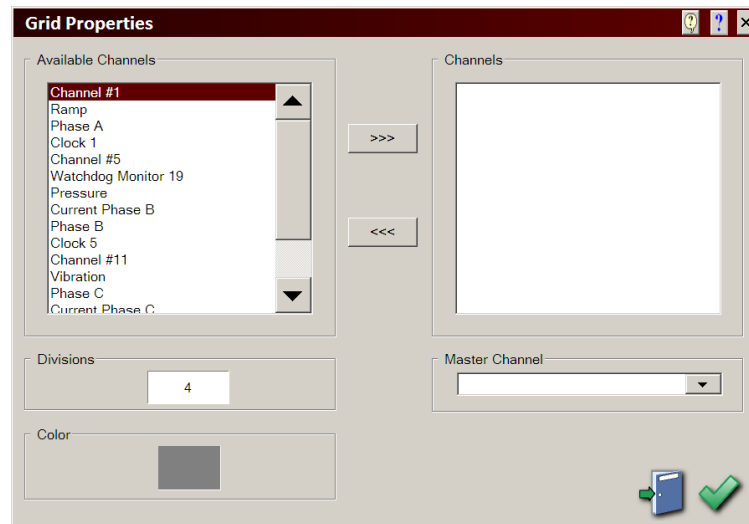

- 2 Select the channels to display by choosing them from the Available Channels list. Then choose the “>>>” button to add them to the Channels list.
- 3 If necessary, select the channels to remove by choosing them from the Channels list. Then choose the “<<<” button to remove them from the Channels list.
- 4 To change the number of grid divisions, choose the Divisions field. A number pad will appear. Enter the number of grid divisions and choose OK.
- 5 To change the color of the grid, choose the Color box. The Color window will open. Select a color and choose OK.
- 6 If there are two or more channels in the Channels list, select a master channel. This affects the display of the channel label area on the right side of the grid. If the label area is small and only one channel label will fit, information for the master channel will be displayed.
- 7 Choose OK.

Editing grids

- 1 Choose the channel label on the right side of the grid. A sub menu will appear.

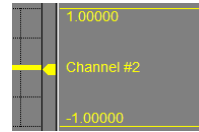

- 2 Choose Properties. The Grid Properties window will open.

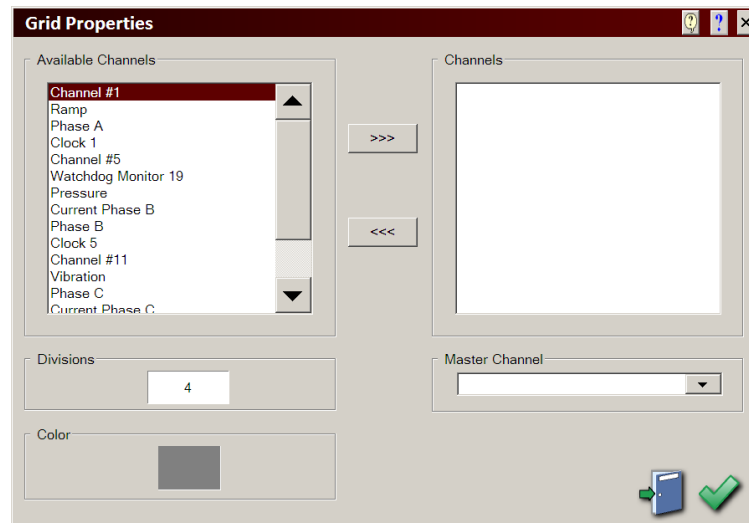

- 3 Select the channels to display by choosing them from the Available Channels list. Then choose the ">>>" button to add them to the Channels list.
- 4 If necessary, select the channels to remove by choosing them from the Channels list. Then choose the "<<<" button to remove them from the Channels list.
- 5 To change the number of grid divisions, choose the Divisions field. A number pad will appear. Enter the number of grid divisions and choose OK.
- 6 To change the color of the grid, choose the Color box. The Color window will open. Select a color and choose OK.
- 7 If there are two or more channels in the Channels list, select a master channel. This affects the display of the channel label area on the right side of the grid. If the label area is small and only one channel label will fit, information for the master channel will be displayed.
- 8 Choose OK.

Moving grids

- 1 Choose the channel label on the right side of the grid. A sub menu will appear.

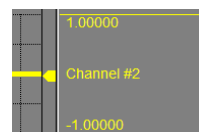

- 2 Choose Move. The channel label text color will change and the grid will be highlighted in the waveform display area.
- 3 Touch and drag up/down anywhere in the waveform display area. Move the grid highlight to the desired location. Choose the grid's channel label. The grid will be moved to the new position. To accommodate this movement, previous grids at and below this position on the display will be moved downward.

Resizing grids

- 1 Choose the channel label on the right side of the grid. A sub menu will appear.

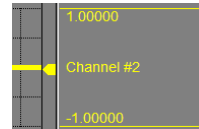

- 2 To resize by moving the position of the grid's top, choose Size Top. The channel label text color will change and the grid top will be highlighted in the waveform display area.

Touch and drag up/down anywhere in the waveform display area. Move the grid top to the desired location. Choose the grid's channel label. The grid top will be moved to the new position. If necessary, other grids will be resized to accommodate the new position.

- 3 To resize by moving the position of the grid's bottom, choose Size Bottom. The channel label text color will change and the grid bottom will be highlighted in the waveform display area.

Touch and drag up/down anywhere in the waveform display area. Move the grid bottom to the desired location. Choose the grid's channel label. The grid bottom will be moved to the new position. If necessary, other grids will be resized to accommodate the new position.

Removing grids

- 1 Choose the channel label on the right side of the grid. A sub menu will appear.

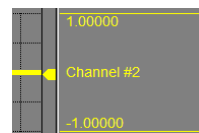

- 2 Choose Remove. The grid will be removed from the display.

Selecting a color for all grids

During the grid setup process, you assigned colors to individual grids using the Grid Properties window. As an alternative, you can quickly apply a color to all grids on the display.

- 1 Choose View >> Grid Color. The Color window will open. Select a color and choose OK. The selected color will be applied to all grids on the display.

Selecting a background color

You can change the background color of the waveform display and channel label areas for contrast with your grid colors.

- 1 Choose View >> Background Color. The Color window will open. Select a color and choose OK. The selected color will be applied to the background.

Events

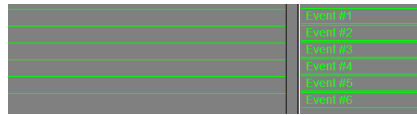

Events are binary signals that can be monitored and recorded along with waveform data. The state of an event signal is referred to as either high or low.



You can customize event location, style, and color to fit the needs of your application.

Event styles

During the event setup process, you will select styles for events. Event styles determine how event signals are drawn on the display. The following event styles are available.

Event Style	Example
Standard	
Bar/Line	
Bar/Off	
Tick	

Adding events

- 1 Choose View >> Add Event. The Event Properties window will open.

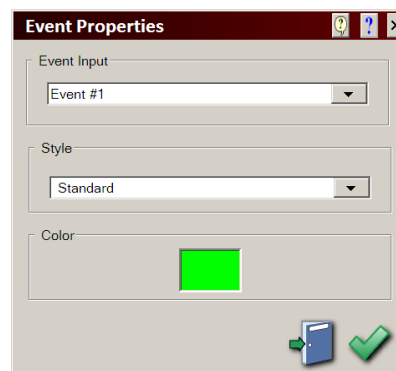

- 2 Select the event input to display by choosing it from the Event Input list.
- 3 Select the event style from the Style list.
- 4 To change the color of the event, choose the color box. The Color window will open. Select a color and choose OK.
- 5 Choose OK.

Editing events

- 1 Choose the event label on the right side of the event. A sub menu will appear.

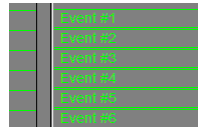

- 2 Choose Properties. The Event Properties window will open.

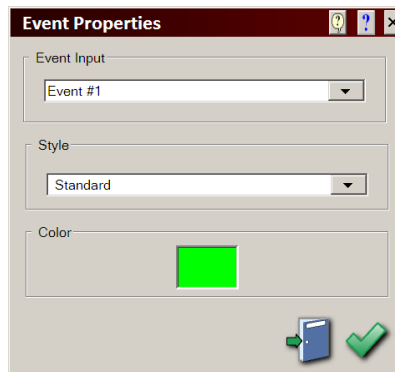

- 3 Select the event input to display by choosing it from the Event Input list.
- 4 Select the event style from the Style list.
- 5 To change the color of the event, choose the color box. The Color window will open. Select a color and choose OK.
- 6 Choose OK.

Moving events

- 1 Choose the event label on the right side of the event. A sub menu will appear.

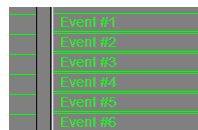

- 2 Choose Move. The event label text color will change and the event will be highlighted in the waveform display area.
- 3 Touch and drag up/down anywhere in the waveform display area. Move the event highlight to the desired location. Choose the event label. The event will be moved

to the new position. To accommodate this movement, previous events at and below this position on the display will be moved downward.

Removing events

- 1 Choose the event label on the right side of the event. A sub menu will appear.

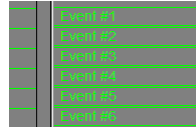

- 2 Choose Remove. The event will be removed from the display.

Showing and hiding pens, channel limits, and the control panel

You can hide some display elements to use more of the screen for viewing waveforms.

- 1 Realtime waveforms are drawn on the display using on-screen pens. To show or hide these pens, choose the Pens button along the right side of the display.

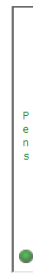

Note: On-screen pens are only available in Realtime mode.

- 2 The channel label area on the right side of the grid displays channel labels and high/low limits. To show or hide this area, choose the Limits button along the right side of the display.

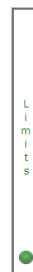

- 3 To show or hide the control panel, choose the Panel button along the right side of the display.

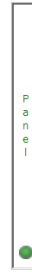

View setup files

View setup files contain information about the display settings. Once a display is set up for a particular application or user, the settings can be saved to a view setup file for later recall. These files can greatly decrease the amount of time spent customizing the display before measurement.

It may be helpful to create a library of view setup files to accommodate multiple tasks and/or users. Additionally, view setup files are portable, so they can be shared with other TMX units.

Saving view setup files

- 1 Choose File >> Save >> View. The Select File window will open.

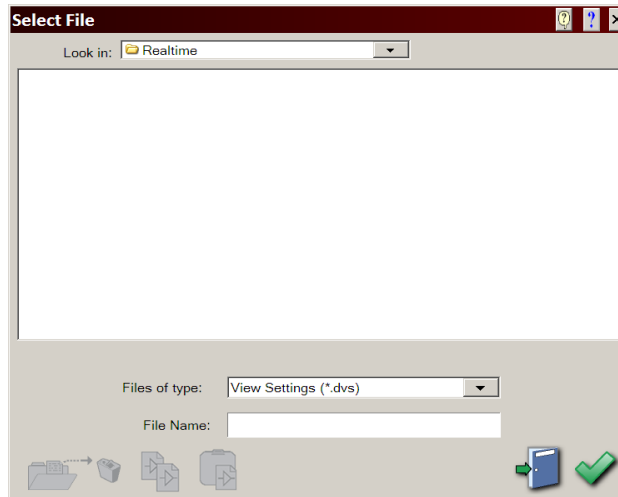

- 2 Choose a destination for the view setup file. By default, the file will be saved on the system drive (C) in the selected folder. If necessary, you can save the file in a different location by choosing the folder list and browsing to a folder.
- 3 Choose the File Name field. A keypad will appear. Enter a file name and choose OK. The specified file name will appear in the field.
- 4 Choose OK.

Loading view setup files

- 1 Choose File >> Load >> View. The Select File window will open.

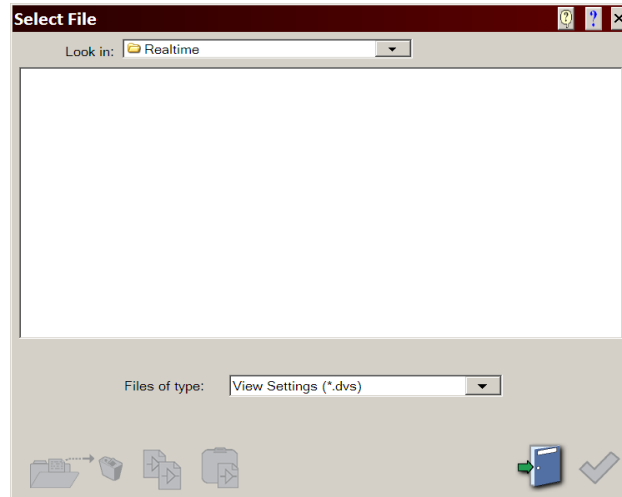

- 2 Select a view setup file to load. By default, files in the default location on the system drive (C) will be displayed. If necessary, you can select a file from a different location by choosing the folder list and browsing to a folder. Choose OK.

Loading view setup files with the control panel

You can use control panel icons to quickly load view setup files.

- 1 Add the view setup file to the control panel.

Choose Settings >> Control Panel to open the Panel Settings window.

Choose the File button. A sub menu will appear. Choose View. The Select File window will open.

Select a view setup file and choose OK. An icon for the selected file will be added to the control panel. Choose OK.



- 2 Load the view setup file from the control panel by choosing the appropriate view setup file icon.

Realtime mode introduction

Realtime mode provides real-time waveform scrolling, monitoring, and data capture capabilities, typically used to view low frequency waveforms. Additionally, almost all system setup options are accessible from Realtime mode.

Accessing Realtime mode

- 1 Choose Configuration >> Realtime from the menu bar. Realtime mode will start.

The following illustration displays a typical Realtime mode screen. Realtime mode screen appearances will vary based on the control panel configuration and other selected options.

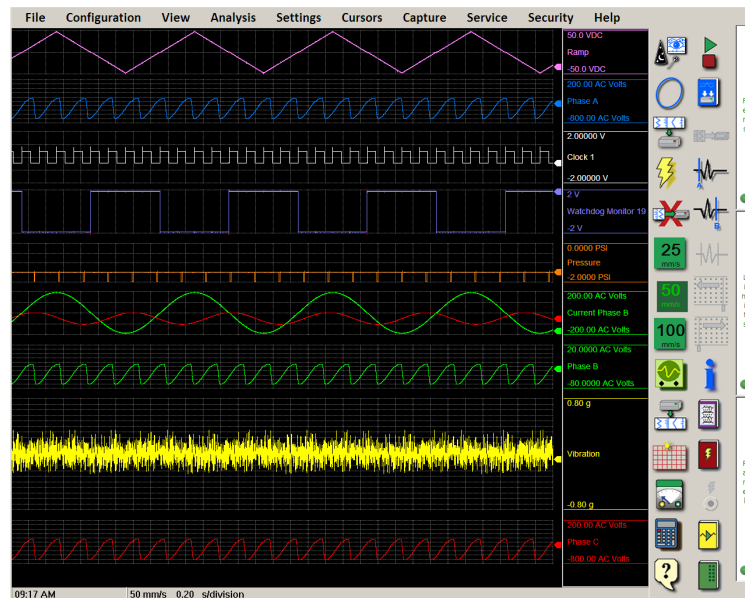

Freezing and running the monitor

- 1 To freeze/run the monitor with the menu bar, choose View >> Freeze Display. Repeat this step to toggle between frozen and running monitor states.
- 2 To freeze/run the monitor with the control panel, choose the Monitor Run/Halt icon.











Repeat this step to toggle between frozen and running monitor states.

Realtime mode default control panel

The following list describes the functions of default control panel icons.

Note: A selection path for each icon is indicated. When the Panel Settings window is open, you can use this path to add the icon to the control panel.

Icon	Description
	<p>Monitor Run/Halt starts and stops the on-screen display from running. <i>View >> Monitor Run/Halt</i></p>
	<p>Set Speed changes the speed of the on-screen chart. In this example, the chart speed will be changed to 5 mm/s when the icon is pressed. Custom speed icons can be configured during the control panel setup process. <i>Settings >> Speed >> mm/s or mm/m</i></p>
	<p>Channel Settings opens the Channel Settings window, which is used to set up amplifier inputs, base channels, derived channels, and event inputs. <i>Settings >> Channels</i></p>
	<p>Trigger Settings opens the Trigger Settings window, which is used to set up data capture triggers and aborts. <i>Capture >> Trigger/Abort Settings</i></p>
	<p>Trigger Indicator indicates when a trigger occurs by displaying a yellow circle. <i>Capture >> Trigger Indicator</i></p>
	<p>Realtime Settings opens the Realtime Settings window, which is used to configure Realtime mode. <i>Settings >> Realtime</i></p>
	<p>Arm Capture arms (starts) a data capture using the configured data capture setup options. <i>Capture >> Arm</i></p>
	<p>Capture Indicator indicates when a data capture is in progress by illuminating. <i>Capture >> Capture Indicator</i></p>

Setting up Realtime mode

- 1 Choose Settings >> Realtime.

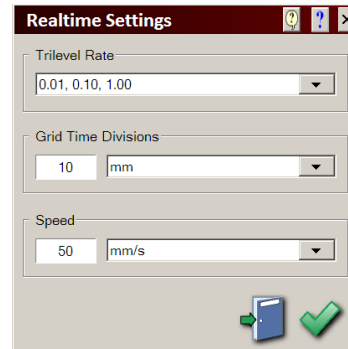

- 2 Select a trilevel rate from the list.

Each trilevel set represents a series of three time intervals (in seconds). The first, second, and third intervals indicate how often small, medium, and large marks will be printed respectively.

- 3 Set the size of the grid time divisions.

- To set the size in millimeters, select the mm option from the list. Then choose the field to the left of the list. A number pad will appear. Enter the size of the grid time divisions and choose OK.
- To set the size based on the trilevel rate, choose Trilevel Slow, Trilevel Medium, or Trilevel Fast from the list.

- 4 Set a chart speed by selecting millimeters per second or millimeters per minute from the list. Then choose the field to the left of the list. A number pad will appear. Enter the chart speed and choose OK.

- 5 Choose OK.

Realtime mode view options

This section describes the view options available in Realtime mode.

Printing signal IDs

Signal IDs are small visual indicators that identify channels. Signal IDs can be printed at any time. This feature is especially helpful for identifying multiple waveforms displayed in a single grid.

- 1 Choose View >> Print IDs.

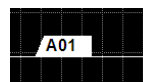

A signal ID indicator will be displayed and printed for each waveform and event.

Printing a full-page mark

Printing a full-page mark creates a vertical line that spans from the top to the bottom of the waveform display monitor.

- 1 Choose View >> Page Mark.

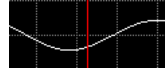

A mark will be printed vertically across all waveforms.

Viewing real-time video

If the TMX-VA option is enabled, you can view real-time video in Realtime mode.

Note: For information about adding the TMX-VA option to your system, please contact Test & Measurement Sales.

Note: For detailed video specifications, see “TMX-VA Optional Software” on page 207.

- 1 Plug the video camera into the VIDEO port on the left side of the recorder.
- 2 Choose View >> Video.

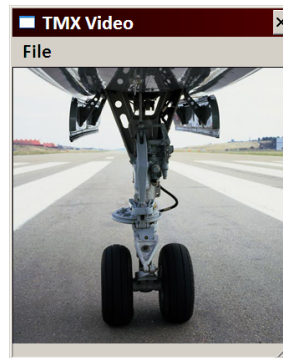

Note: A small latency may occur when viewing video in Realtime mode. However, when recording video in a data capture and viewing in Review mode, no latency will be present.

Related Topics:

- *Selecting a video standard on page 192*

Global setup files

Global setup files contain all system setup information that can be saved to a file for later recall. These files can be considered a “complete setup” that can be saved and loaded as needed.

It may be helpful to create a library of global setup files to accommodate multiple tasks and/or users. Additionally, global setup files are portable, so they can be shared with other TMX units.

Saving global setup files

- 1 Choose File >> Save >> Global. The Select File window will open.

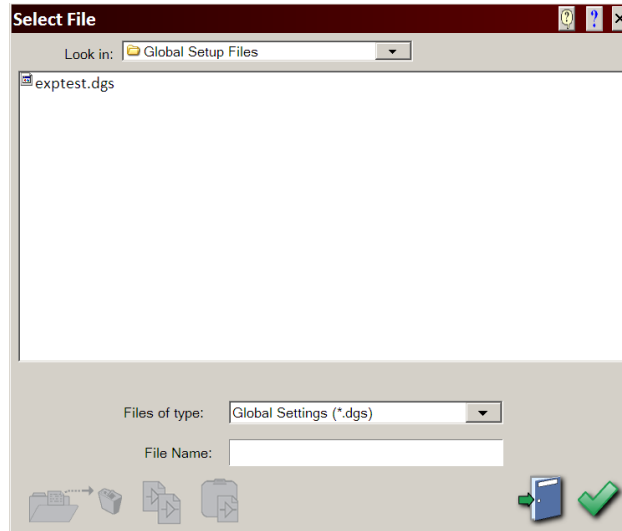

- 2 Choose a destination for the global setup file. By default, the file will be saved on the system drive (C) in the selected folder. If necessary, you can save the file in a different location by choosing the folder list and browsing to a folder.
- 3 Choose the File Name field. A keypad will appear. Enter a file name and choose OK. The specified file name will appear in the field.
- 4 Choose OK.

Loading global setup files

- 1 Choose File >> Load >> Global. The Select File window will open.

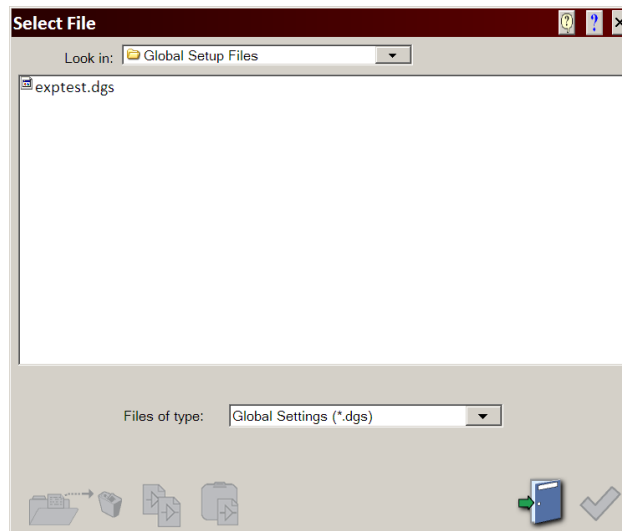

- 2 Select a global setup file to load. By default, files in the default location on the system drive (C) will be displayed. If necessary, you can select a file from a different location by choosing the folder list and browsing to a folder. Choose OK.

Loading global setup files with the control panel

You can use control panel icons to quickly load global setup files.

- 1** Add the global setup file to the control panel.

Choose Settings >> Control Panel to open the Panel Settings window.

Choose the File button. A sub menu will appear. Choose Global. The Select File window will open.

Select a global setup file and choose OK. An icon for the selected file will be added to the control panel. Choose OK.



- 2** Load the global setup file from the control panel by choosing the appropriate global setup file icon.

Data capture overview

This section provides an overview of data capture concepts and the data capture process.

Data capture concepts

The following concepts are commonly used during data capture-related tasks.

Data capture

Data capture is the process of sampling signals and saving the sampled data to the data capture hard drive.

Data capture record (DCR) file

The recorder saves data capture information in a type of file format known as a DCR file. Base file names can be assigned to these files as part of the data capture setup process.

Sample rates

Sample rates define the speed at which signals are sampled. This rate is defined in units of Hz (hertz), the number of samples per second.

Trigger

A trigger is a user-defined event that starts the post-trigger recording phase of a data capture.

Data capture storage allocation

The data capture storage allocation determines the size of the data capture.

An estimate of needed disk space for the DCR file is derived based on the data capture storage allocation and sample rate specified.

Pre-trigger and post-trigger data

Pre-trigger data makes up the sequence of samples recorded prior to the occurrence of a trigger. Similarly, post-trigger data makes up the sequence of samples recorded after the occurrence of a trigger.

Pre-trigger percent

The pre-trigger percent is the amount of space in a data capture that is reserved for pre-trigger data.

This amount is defined by a percentage of the whole data capture size. For example, a pre-trigger percentage of 25% would result in a data capture file that contains 25% pre-trigger data and 75% post-trigger data.

Arm

Arming starts the data capture function. When armed, the system monitors trigger and abort conditions. If a trigger occurs, the post-trigger recording phase will begin. If an abort occurs, the data capture will be canceled.

- If a pre-trigger recording percentage is used, the pre-trigger recording phase begins when the system is armed. Pre-trigger samples will be acquired and stored up to the specified amount. When the specified amount of pre-trigger data has been stored, the oldest sample will be replaced by the most recent, creating a circular buffer.
- If no pre-trigger recording percentage is used, samples will be recorded up to the specified amount.

Auto re-arm

The auto re-arm feature automatically re-arms a new capture immediately after the current capture is complete. Automatically re-arming data captures is helpful when analyzing repetitive events, but it can produce a large number of captures depending on trigger conditions.

Archive

The recorder utilizes two separate hard drives: the data capture drive and the system drive. The data capture drive is used to record signal samples. The system drive contains the Windows operating system and can be used to archive files.

Archiving a data capture copies the DCR file from the capture drive to the system drive, a USB storage device, or a network drive. The auto archive feature automatically archives the DCR file immediately after the capture is complete.

Abort

An abort is a user-defined event that stops a data capture in progress. When an abort condition is detected, any currently running data capture will be stopped. All data captured up to this point is saved.

Data capture process

This section provides an overview of the data capture process.

1 Set up the data capture

The data capture setup process involves entering a base file name for the data capture, specifying storage allocation options, defining and selecting channel sample rates, and activating the desired automation options.

2 Set up triggers and aborts

The trigger and abort setup process involves defining conditions that initiate triggers and aborts.

3 Arm the data capture

Arming starts the data capture function. When armed, the system monitors trigger and abort conditions. If a trigger occurs, the post-trigger recording phase will begin. If an abort occurs, the data capture will be canceled.

- If a pre-trigger recording percentage is used, the pre-trigger recording phase begins when the system is armed. Pre-trigger samples will be acquired and stored up to the specified amount. When the specified amount of pre-trigger data has been stored, the oldest sample will be replaced by the most recent, creating a circular buffer.
- If no pre-trigger recording percentage is used, samples will be recorded up to the specified amount.

4 Post-trigger recording

When a trigger occurs, the post-trigger recording phase will begin. Samples will be acquired and saved until the data capture storage allocation is met or the capture is aborted.

Data capture setup

This section provides instructions for setting up data captures.

Setting up a data capture

- 1 Choose Capture >> Settings. The Capture Settings window will open.

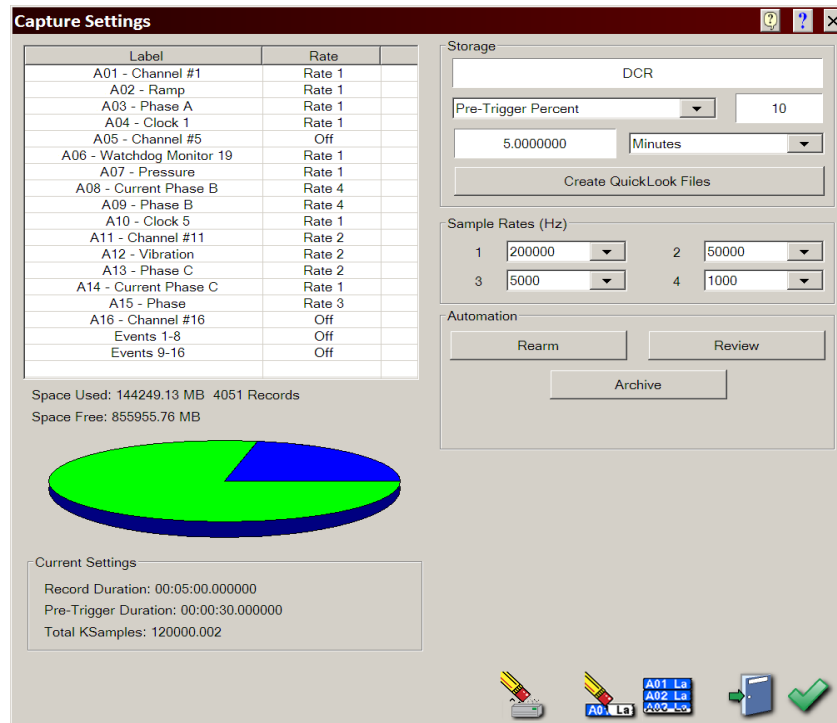

In the lower-left corner, a graphical representation of hard drive space is displayed. The following color key is used:

- **Green** - Indicates the space available for data captures.
 - **Blue** - Indicates the space already containing data captures.
 - **Yellow** - Indicates the amount of space the next valid data capture will use.
 - **Red** - Indicates that the next capture is too large for the hard drive.
- 2 Specify a DCR base file name by choosing the text field in the Storage options. A keypad will appear. Enter a base file name for the DCR file and choose OK.

When a data capture is saved, the time and date of the capture are automatically appended to the end of the base file name.

- Specify pre-trigger storage options by deciding if pre-trigger data should be included in the data capture.

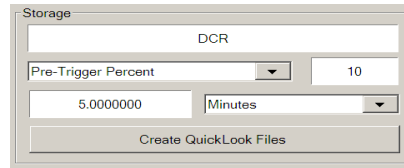

- If the data capture will contain pre-trigger data, select the Pre-Trigger Percent option. Then choose the Pre-Trigger Percent field. A number pad will appear.

Enter the percentage of the file that will be used for pre-trigger data and choose OK. If the trigger point represents the end of the data of interest, choose a high pre-trigger percentage. If it precedes the data of interest, choose a low number.

- If the data capture will not contain pre-trigger data, select the No Trigger option.

- Specify the size of the capture by defining a data capture storage allocation. The size can be defined in units of time (hours, minutes, or seconds) or number of samples (KS/channel).

Select a unit of measure from the drop-down list. Then choose the quantity field to the left of the drop-down list. A number pad will appear. Enter the desired quantity and choose OK.

- Select whether to create QuickLook files for the data capture.

When you view files in Review mode, the system reads the file directly from the data capture drive or system drive. For data records with very high compressions, the review process may become slow.

You can create QuickLook files dynamically during a data capture to generate multiple review files at various compressions. These files are then used to speed up the time to review records at large compressions.

Note: QuickLook files cannot be used with Review mode filters. If you enable a filter during review, the data will not be read from the QuickLook files. Instead, it will be read directly from the original file. Review mode analysis windows will also be based on data from the original file.

- Specify sample rates to define the speeds at which channels are sampled. Sample rates are defined in units of Hz (hertz), the number of samples per second. You can select up to four sample rates.

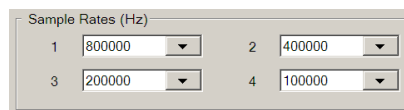

Select the highest sample rate you plan to use from the first list. Then select the second, third, and fourth highest rates using the other lists.

Subsequent sample rates can be set to a value up to half of the previous rate. For example, if you choose 80000 for rate 1, you can choose up to 40000 for rate 2.

- 7 Select the channels to include in the data capture, and the sample rate for each channel.

Select a channel and choose the Rate column heading. A list of sample rate options will appear. To include the channel in the data capture, select Rate 1, Rate 2, Rate 3, or Rate 4. To exclude the channel from the data capture, select Off.

Label	Rate	
A01 - Channel #1	Rate 1	
A02 - Ramp	Rate 1	
A03 - Phase A	Rate 1	
A04 - Clock 1	Rate 1	
A05 - Channel #5	Off	
A06 - Watchdog Monitor 19	Rate 1	
A07 - Pressure	Rate 1	
A08 - Current Phase B	Rate 4	
A09 - Phase B	Rate 4	
A10 - Clock 5	Rate 1	
A11 - Channel #11	Rate 2	
A12 - Vibration	Rate 2	
A13 - Phase C	Rate 2	
A14 - Current Phase C	Rate 1	
A15 - Phase	Rate 3	
A16 - Channel #16	Off	
Events 1-8	Off	
Events 9-16	Off	

- 8 Specify automation preferences by choosing whether to enable automatic re-arm, review, and archive options.

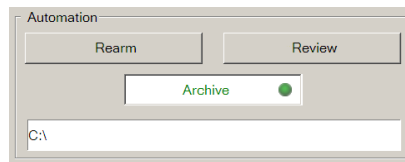

- To automatically re-arm the capture immediately after the current capture is complete, choose the Rearm option. This feature cannot be used if Auto Review is enabled.

Automatically re-arming data captures is helpful when analyzing repetitive events, but it can produce a large number of captures depending on trigger conditions.

- To automatically open the DCR file in Review mode immediately after the data capture is complete, choose the Review option. This feature cannot be used if Auto Rearm is enabled.
- To automatically archive the DCR file to the system or other drive immediately after the capture is complete, choose the Archive option. A file location field will appear.

Choose the file location field. The Select Folder window will open. Browse to the desired archive folder and choose OK.

- 9 Choose OK.

Setting up the IRIG time code using the TMX-TTLIRB option

If the TMX-TTLIRB option is enabled, an IRIG B time code can be captured during the data capture process.

Note: For information about adding the TMX-TTLIRB option to your system, please contact Test & Measurement Sales.

Note: The file size limit for data captures using the TMX-TTLIRB time code is 1 GB.

The IRIG B time code can be captured using an event channel that is decoded in the review process to allow measurement in absolute time. A minimum sample rate of 10 KHz must be used, and the capture duration must be at least 2 seconds. All measurements are accurate to one millisecond.

- 1 Choose Capture >> Settings. The Capture Settings window will open.

If the TMX-TTLIRB option is installed, the IRIG Event list box will be available in this window.

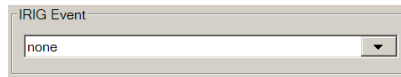

- 2 Ensure that used sample rates are 10000 Hz or greater.
- 3 Ensure that the capture duration is at least 2 seconds.
- 4 In the channel list, ensure that events are captured.
- 5 Select the event input that will be used for the IRIG B signal input.

For example, if Event #2 is selected, utility / DIO port pin number 2 will be used for IRIG B input.

- 6 Choose OK.

Once a data capture has been saved using these settings, the IRIG B time code information can be viewed in Review mode. To view IRIG B time choose View >> Status Text Format >> Absolute Time from the menu bar in Review mode.

Related Topics:

- *Utility / DIO port pin configuration on page 12*

Setting up a video capture

If the TMX-VA option is enabled, and you are using an external video camera, video can be captured during the data capture process.

Note: For information about adding the TMX-VA option to your system, please contact Test & Measurement Sales.

- 1 Plug the video camera into the VIDEO port on the left side of the recorder.
- 2 Choose Capture >> Settings. The Capture Settings window will open.

If the TMX-VA option is installed, the Video Capture Settings will be available in this window.

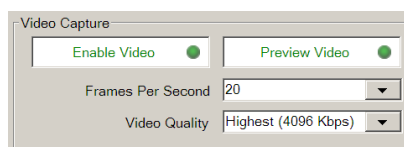

- 3 Choose Enable Video to record video during the data capture. Other video options will become available.
- 4 To display video during the data capture, choose Preview Video.
- 5 Select the number of frames per second for the video. Select the video quality.

More frames per second and higher video quality will result in a larger video file size. The following table provides examples of video file size based on various settings.

Note: *The content of the video will also affect file size due to video compression. Video with little motion will result in a smaller file than a video with continuous motion.*

Capture Duration	Frames per Second	Video Quality	Video File Size
10 Minutes	Highest - 30	High - 4 Mbps	315 Mb
10 Minutes	Medium - 15	High - 4 Mbps	195 Mb
10 Minutes	Low - 5	High - 4 Mbps	65 Mb
10 Minutes	Highest - 30	High - 4 Mbps	315 Mb
10 Minutes	Highest - 30	Medium - 2 Mbps	150 Mb
10 Minutes	Highest - 30	Low - 500 Kbps	75 Mb
10 Minutes	Highest - 30	High - 4 Mbps	315 Mb
30 Minutes	Highest - 30	High - 4 Mbps	950 Mb
1 Hour	Highest - 30	High - 4 Mbps	1900 Mb

- 6 Choose OK.

When a data capture is started, video will be captured for the duration of the capture.

Note: *The TMX-VA option does not work with the software triggering capabilities of the TMX including pre-trigger recording. Any data capture that requires video must be manually triggered.*

Related Topics:

- *Left side view on page 8*
- *Selecting a video standard on page 192*

Triggers and aborts

A trigger is a user-defined event that starts the post-trigger recording phase of a data capture. An abort is a user-defined event that stops a data capture in progress. When

an abort condition is detected, any currently running data capture will be stopped. All data captured up to this point is saved.

Trigger and abort conditions can be defined as the manual push of a button, the receiving of an external signal, or when specific channels detect data at certain values. Triggers can also be based on an elapsed time period or a specific date/time.

The following trigger/abort types are available:

- **Window Trigger/Abort** - This trigger/abort occurs when signals move inside or outside a predetermined window of values. The user provides the high and low level for the window.
- **Edge Trigger/Abort** - This trigger/abort occurs when signals move above or below a certain level. The user provides this level.
- **Slew Trigger/Abort** - This trigger/abort occurs when a signal's rate of change (known as "slew" or "slope") reaches or drops below a certain value. The user provides the change in amplitude and the length of time, which are used to calculate slew.
- **Manual Trigger/Abort** - This trigger/abort occurs when the user produces a trigger/abort via the menu bar or control panel.
- **External Trigger/Abort** - This trigger/abort uses an external low (0V) signal via the Utility / DIO port to produce a trigger or abort.
- **Periodic Triggers** - The Periodic trigger occurs after a specific amount of elapsed time. When a periodic trigger occurs, this process will be repeated.
- **Time Triggers** - The Time trigger occurs at a specific date and time.
- **Event Trigger/Abort** - This trigger/abort uses external signals via the event port to produce a trigger or abort, based on the state of the events.

Enabling and disabling triggers and aborts

- 1 Choose Capture >> Trigger/Abort Settings. The Trigger Settings window will open.

- 2 Choose the Main Or tab.

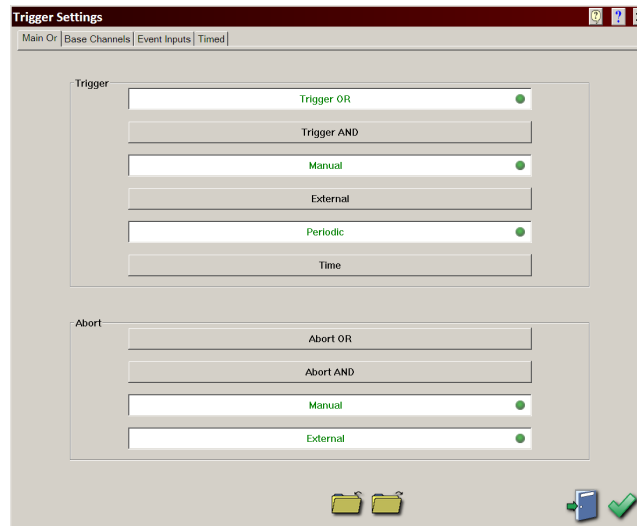

- 3 Enable and disable triggers or aborts by choosing the trigger/abort buttons. Buttons that appear “pressed in” indicate enabled triggers/aborts.

There are ten groups of triggers and aborts that can be enabled/disabled from this screen. All triggers/aborts fall into one of these categories.

- Trigger OR, Abort OR
- Trigger AND, Abort AND
- Manual Trigger, Manual Abort
- External Trigger, External Abort
- Periodic Trigger
- Time Trigger

Note: *Event triggers/aborts are the exception to this rule and are configured separately in the Event Inputs tab.*

- 4 The next step in the setup process depends on what kind of trigger/abort you are setting up.
 - **Manual** triggers/aborts require no additional setup. Simply choose OK to close the Trigger Settings window.
 - **External** triggers/aborts require that you set up the Utility / DIO port, if you have not already done so.
 - **AND/OR** triggers/aborts have their own setup procedures.
 - **Periodic** and **Time** triggers have their own setup procedures.

Related Topics:

- *AND/OR triggers/aborts on page 108*
- *Periodic and time triggers on page 115*
- *Viewing and modifying utility / DIO port settings on page 191*

Trigger Settings window overview

The Trigger Settings window (Capture >> Trigger/Abort Settings) is used to set up triggers and aborts. The Trigger Settings window provides two layout options.

- **List view** - You can change settings in list view by selecting a channel and choosing the column heading for the setting you want to change. Some options can be configured for a group of channels at the same time by selecting a group of channels prior to choosing a column heading. In this case, setup information will be applied to all selected channels.

Some options must be configured for each channel individually, or in groups based on compatible channels.

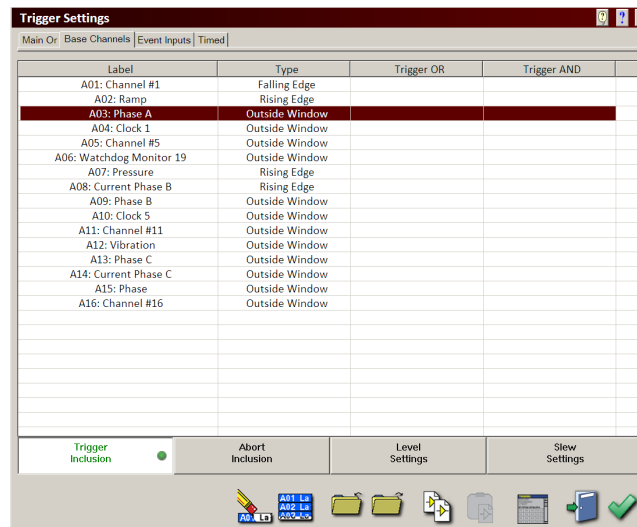

Use the buttons below the list to display other columns.

- **Graphical view** - You can change settings in graphical view by selecting a single channel and the appropriate options for the channel.

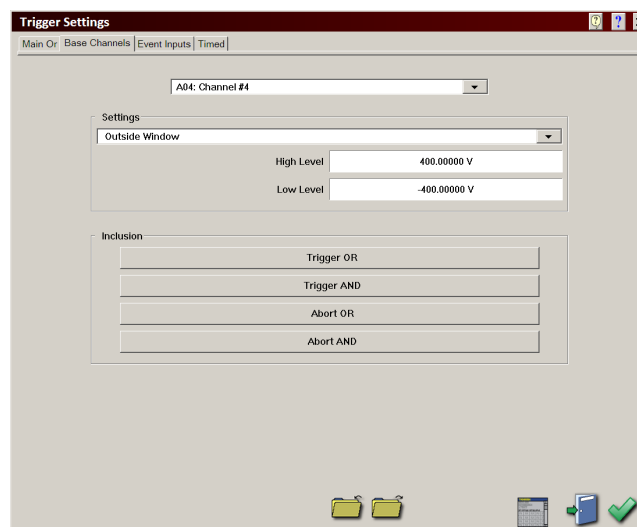

You can switch between list view and graphical view by choosing the Toggle Layout icon.



AND/OR triggers/aborts

All AND/OR triggers and aborts use AND/OR logic to determine when to activate; they can be based on an amplitude window, level (edge), or slew.

- **OR** triggers/aborts will activate if **any** OR conditions have been met.

For example: A one-channel OR trigger/abort will activate as soon as its conditions are met; the status of the other channels is irrelevant. A two-channel OR trigger/abort will activate as soon as either of the channels' conditions are met

- **AND** triggers/aborts will activate if (and only if) **all** AND conditions have been met.

For example: A two-channel AND trigger/abort will activate as soon as both channels' conditions are met; nothing will occur if one channel meets its conditions without the other. A three-channel trigger/abort will activate as soon as all three channels' conditions are met.

Any channel can be included or removed from either trigger/abort by adjusting its settings in the Trigger Settings window.

Setting up a Window trigger/abort

This trigger/abort occurs when signals move inside or outside a predetermined window of values. The user provides the high and low level for the window.

- 1 Choose Capture >> Trigger/Abort Settings. The Trigger Settings window will open.
- 2 Choose the Base Channels tab.

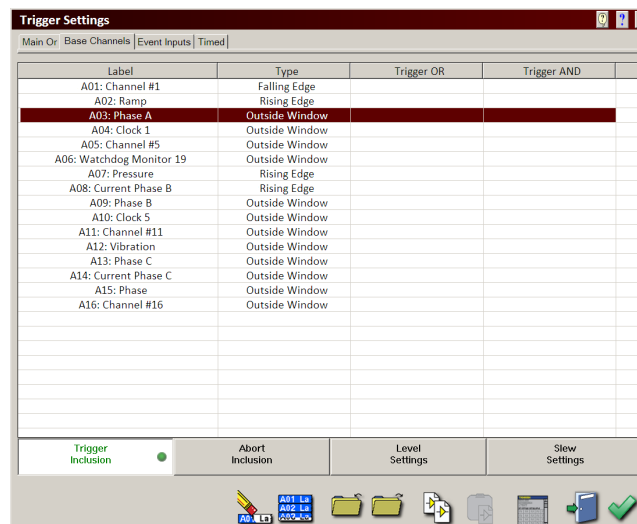

- 3 Select the channel you want to apply the trigger/abort to from the channel list.
- 4 Choose the Type column heading. Select the window type from the list.
 - **Outside window** - Choose this option to set the trigger/abort to occur when the signal exceeds the upper boundary or drops below the lower boundary.
 - **Inside window** - Choose this option to set the trigger/abort to occur when the signal exceeds the lower boundary but remains below the upper boundary.
- 5 Define the amplitude window boundaries.
 - Choose the High Level column heading. A number pad will appear. Enter the high value for the amplitude window and choose OK.
 - Choose the Low Level column heading. A number pad will appear. Enter the low value for the amplitude window and choose OK.
- 6 Set the trigger/abort as AND, OR, or both.
 - **Trigger OR** - To include the channel in the OR trigger, choose the Trigger OR column heading and choose Include.
 - **Trigger AND** - To include the channel in the AND trigger, choose the Trigger AND column heading and choose Include.
 - **Abort OR** - To include the channel in the OR abort, choose the Abort OR column heading and choose Include.
 - **Abort AND** - To include the channel in the AND abort, choose the Abort AND column heading and choose Include.
- 7 Choose OK.

Related Topics:

- *AND/OR triggers/aborts on page 108*

Setting up an Edge trigger/abort

This trigger/abort occurs when signals move above or below a certain level. The user provides this level.

- 1 Choose Capture >> Trigger/Abort Settings. The Trigger Settings window will open.

2 Choose the Base Channels tab.

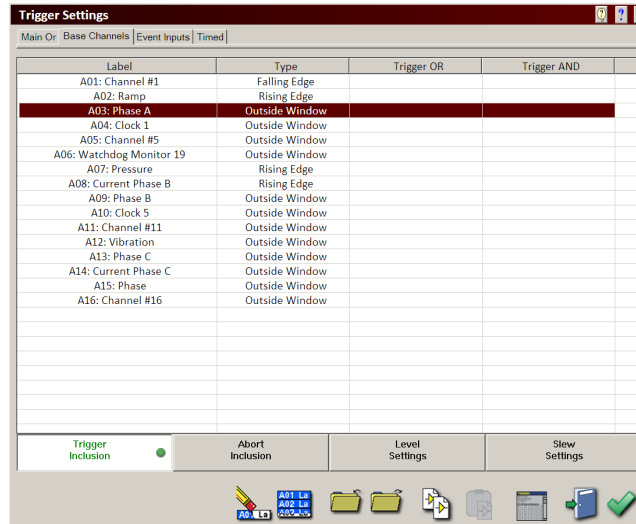

3 Select the channel you want to apply the trigger/abort to from the channel list.

4 Choose the Type column heading. Select the edge type from the settings list.

- **Rising Edge** - Choose this option to set the trigger/abort to occur when the signal rises above a specific level.
- **Falling Edge** - Choose this option to set the trigger/abort to occur when the signal drops below a specific level.

5 Choose the High Level column heading. A number pad will appear. Enter the edge level and choose OK.

Note: The Low Level setting is not used in Rising Edge or Falling Edge triggers/aborts.

6 Set the trigger/abort as AND, OR, or both.

- **Trigger OR** - To include the channel in the OR trigger, choose the Trigger OR column heading and choose Include.
- **Trigger AND** - To include the channel in the AND trigger, choose the Trigger AND column heading and choose Include.
- **Abort OR** - To include the channel in the OR abort, choose the Abort OR column heading and choose Include.
- **Abort AND** - To include the channel in the AND abort, choose the Abort AND column heading and choose Include.

7 Choose OK.

Related Topics:

- *AND/OR triggers/aborts on page 108*

About Slew triggers/aborts

This trigger/abort occurs when a signal's rate of change (known as "slew" or "slope") reaches or drops below a certain value. The user provides the change in amplitude and the length of time, which are used to calculate slew.

The following example illustrates important concepts related to this trigger/abort. You may want to refer to this example as you set up a Slew trigger/abort.

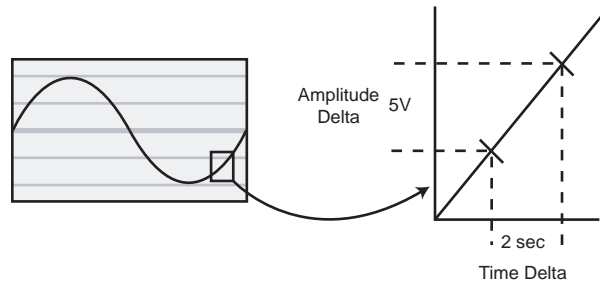

Amplitude Delta - The Amplitude Delta indicates the slew voltage span. The slope of this voltage span with respect to the Time Delta will set the trigger point.

For this example, Amplitude Delta is set to 5 V.

Time Delta - The Time Delta indicates the time to monitor the slope change of the Amplitude Delta span. This can be set from 500 ns to 8.3886075 seconds. This is done by choosing a number that when multiplied with 0.0000005 (500 ns, the shortest time you can set) results in the Time Delta.

For this example, Time Delta is set to 4000000, resulting in a Time Delta of 2 seconds.

Slew Spikes/Dropouts - A slew spike occurs when the slew rate of the Amplitude Delta with respect to the Time Delta rises above the specified parameters.

Likewise, a slew dropout occurs when the slew rate of the Amplitude Delta with respect to the Time Delta falls below the specified parameters.

- If using slew spikes, the following scenario would result in a trigger/abort: Signal Slew Rate = $7V / 2 \text{ sec} = 3.5 \text{ V/s}$

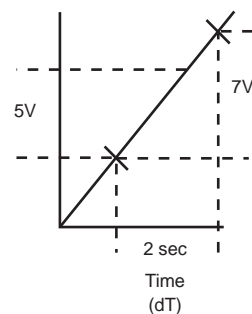

- If using slew dropouts, the following scenario would result in a trigger/abort:
 $\text{Signal Slew Rate} = 3\text{V} / 2\text{ sec} = 1.5\text{ V/s}$

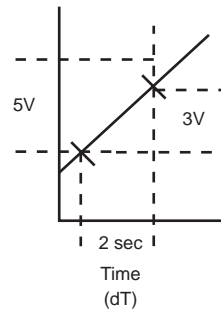

Setting up a Slew trigger/abort

This trigger/abort occurs when a signal's rate of change (known as "slew" or "slope") reaches or drops below a certain value. The user provides the change in amplitude and the length of time, which are used to calculate slew.

- 1 Choose Capture >> Trigger/Abort Settings. The Trigger Settings window will open.
- 2 Choose the Base Channels tab.

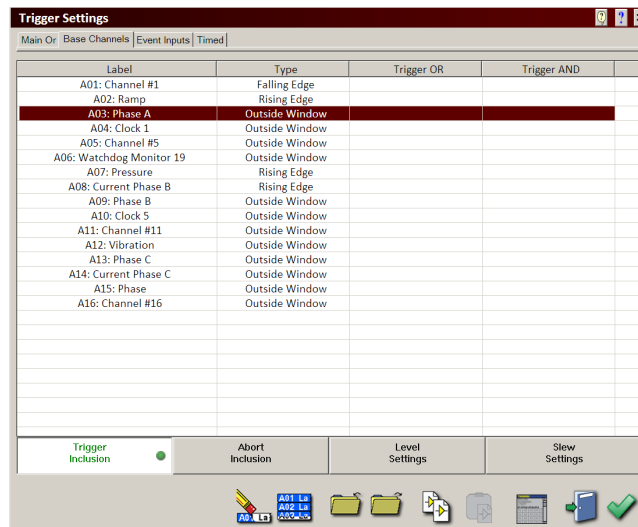

- 3 Select the channel you want to apply the trigger/abort to from the channel list.

- 4 Choose the Type column heading. Select the slew type from the list.
 - **Slew Spikes** - Choose this option to set the trigger/abort to occur when the slew rises above the chosen rate.
 - **Slew Dropout** - Choose this option to set the trigger/abort to occur when the slew falls below the chosen rate
- 5 Define the slew rate.
 - Choose the Time Delta column heading. A number pad will appear. Enter the time delta value and choose OK.
 - Choose the Amplitude Delta column heading. A number pad will appear. Enter the amplitude delta value and choose OK.
- 6 Set the trigger/abort as OR.
 - **Trigger OR** - To include the channel in the OR trigger, choose the Trigger OR column heading and choose Include.
 - **Abort OR** - To include the channel in the OR abort, choose the Abort OR column heading and choose Include.

Note: *Trigger/Abort AND logic cannot be used on slew triggers/aborts.*

- 7 Choose OK.

Related Topics:

- *AND/OR triggers/aborts on page 108*

Event triggers/aborts

An Event Trigger/Abort occurs when event inputs meet their change in logic state. This is communicated through the Utility / DIO port, and is not affected by any of the channel waveforms.

There are two types of Event triggers/aborts:

- **Pattern** - An event pattern trigger/abort occurs each time all events meet the selected logic state (high, low, glitch, don't care). The user provides the state for each event.
- **Edge** - An event edge trigger/abort occurs any time at least one of the events changes states in a specific direction (rising, falling, either). The user provides this direction for each event.

Setting up an Event trigger/abort

- 1 Choose Capture >> Trigger/Abort Settings. The Trigger Settings window will open.

- 2 Choose the Event Inputs tab.

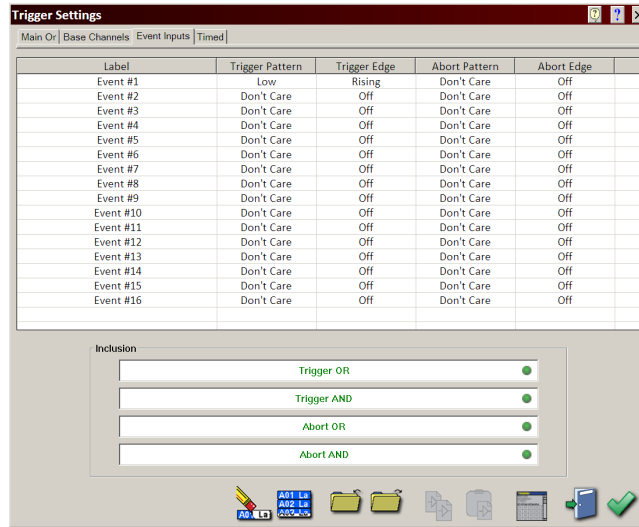

- 3 Select the event you want to apply the trigger/abort to from the event list.

- 4 To set an event pattern trigger/abort, choose the Trigger Pattern or Abort Pattern column heading. Select a pattern option. Remember that all the events must meet their states in order for an event pattern trigger or abort to occur.
 - **Don't Care** - If the Don't Care option is chosen, changes in the selected event will not be considered in the trigger/abort pattern.
 - **Low** - If the Low option is chosen, a trigger/abort will occur when the selected event is in its low state (assuming all other event state trigger/abort conditions are met).
 - **High** - If the High option is chosen, a trigger/abort will occur when the selected event changes to its high state (assuming all other event state trigger/abort conditions are met).
 - **Glitch** - If the Glitch option is chosen, a trigger/abort will occur any time the selected event changes state in any way; low to high or high to low (assuming all other event state trigger/abort conditions are met).
- 5 To set an event edge trigger/abort, choose the Trigger Edge or Abort Edge column heading. Select an edge option. Remember that a trigger or abort will occur whenever any one of the events meets its state.
 - **Off** - If the Off option is chosen, changes in the selected event will not cause a trigger/abort to occur.
 - **Rising** - If the Rising option is chosen, a trigger/abort will occur whenever the selected event changes to its high state.
 - **Falling** - If the Falling option is chosen, a trigger/abort will occur whenever the selected event changes to its low state.
 - **Either** - If the Either option is chosen, a trigger/abort will occur any time the selected event changes state in any way; low to high or high to low.
- 6 Set the event triggers/aborts as AND, OR, or both.
 - **Trigger OR** - Choose this option to include events in the OR trigger.
 - **Trigger AND** - Choose this option to include events in the AND trigger.
 - **Abort OR** - Choose this option to include events in the OR abort.
 - **Abort AND** - Choose this option to include events in the AND abort.
- 7 Choose OK.

Related Topics:

- *AND/OR triggers/aborts on page 108*

Periodic and time triggers

Periodic and time triggers are based on elapsed time and a specific date/time respectively.

Setting up a Periodic trigger

The Periodic trigger occurs after a specific amount of elapsed time. When a periodic trigger occurs, this process will be repeated.

- 1 Choose Capture >> Trigger/Abort Settings. The Trigger Settings window will open.
- 2 Choose the Timed tab.

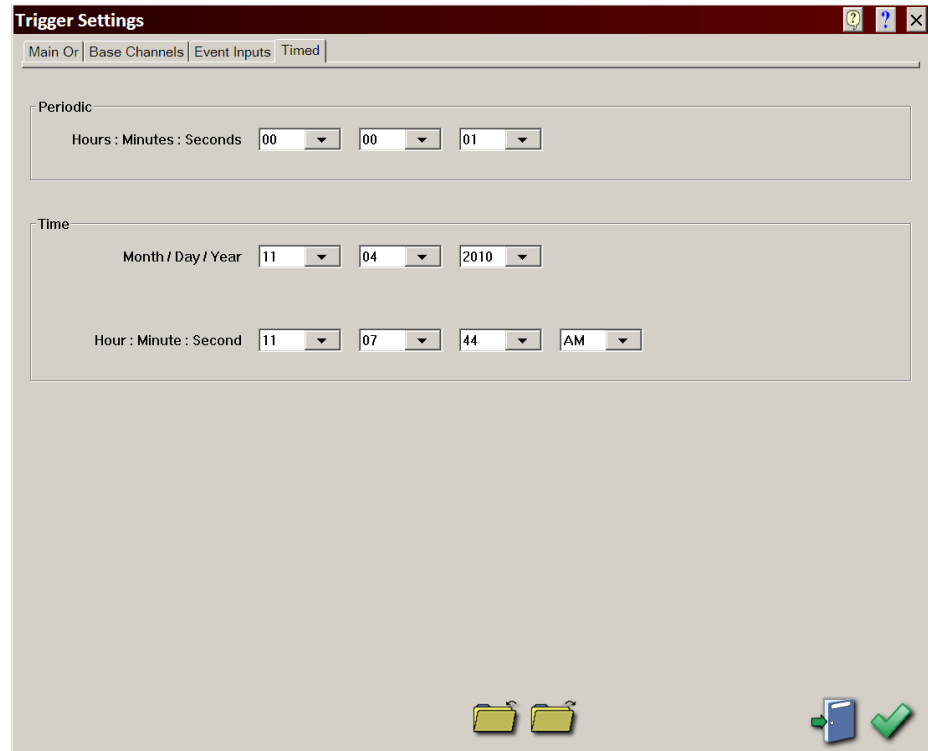

- 3 Use the Periodic options to select how often a trigger should occur. For example, if a trigger should occur every 10 minutes, choose a value of 10 in the Minutes field.
- 4 Choose OK. The clock period will start.

Setting up a Time trigger

The Time trigger occurs at a specific date and time.

- 1 Choose Capture >> Trigger/Abort Settings. The Trigger Settings window will open.

- 2 Choose the Timed tab.

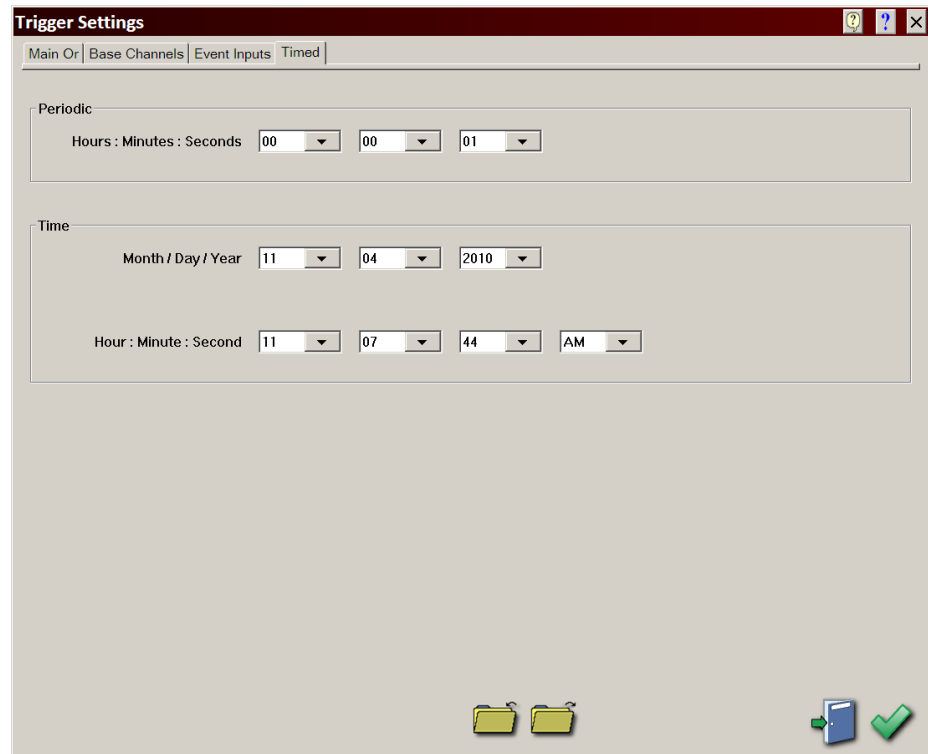

- 3 Use the Time options to select the date and time when a trigger should occur.
- 4 Choose OK.

Performing a data capture

When the data capture setup, trigger setup, and abort setup tasks are complete, the data capture can be initiated by arming the system.

Arming starts the data capture function. When armed, the system monitors trigger and abort conditions. If a trigger occurs, the post-trigger recording phase will begin. If an abort occurs, the data capture will be canceled.

- If a pre-trigger recording percentage is used, the pre-trigger recording phase begins when the system is armed. Pre-trigger samples will be acquired and stored up to the specified amount. When the specified amount of pre-trigger data has been stored, the oldest sample will be replaced by the most recent, creating a circular buffer.
- If no pre-trigger recording percentage is used, samples will be recorded up to the specified amount.

When a trigger occurs, the post-trigger recording phase will begin. Samples will be acquired and saved until the data capture storage allocation is met or the capture is aborted.

- 1 Choose Capture >> Arm. The Capture Progress window will open.

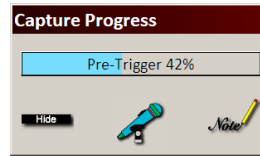

If the data capture includes pre-trigger data, the recorder will begin recording pre-trigger data.

- 2 Wait for a trigger or abort to occur based on the trigger and abort settings.
 - If manual triggers are used, manually trigger the data capture when appropriate by choosing Capture >> Trigger.

After a trigger occurs, the data capture will complete automatically and save the results to a file.

Note: If automatic re-arming is enabled, the system will continually re-arm the data capture.

- If manual aborts are used, manually abort the data capture when appropriate by choosing Capture >> Abort.

Adding notes to data captures

During a data capture, you can insert text notes that will be saved as part of the data capture file. These notes will later be available for viewing and editing in Review mode.

- 1 When a data capture is in progress, the Capture Progress window will be open.

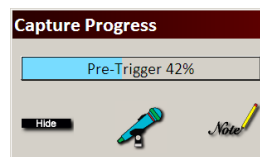

- 2 Choose the Note icon to add a text note. A keypad will appear.



- 3 Enter the note text and choose OK. The note will be saved as part of the data capture. To enter another note, repeat this process.

You can take as much time as needed to enter a note. Notes are embedded in the data capture at the point in time the Note icon was touched.

Recording audio in data captures

If the TMX-VA option is enabled, you can record real-time audio as part of your data capture.

Note: For information about adding the TMX-VA option to your system, please contact Test & Measurement Sales.

- 1 Position the microphone at the desired sound source. Plug the microphone into the pink audio jack on the side of the recorder.

Note: When you plug a device into an audio jack, an audio control window may open to allow configuration of the device. Leave the default settings unchanged and choose OK twice to close this window. If you need additional assistance with this window, please contact Technical Support.

- 2 Start a data capture. When a data capture is in progress, the Capture Progress window will be open.

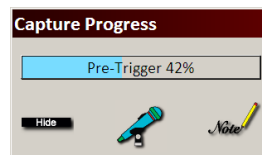

- 3 Start recording audio by choosing the microphone icon. When you are finished recording audio, choose the microphone icon again to stop recording.



Repeat this step to record additional audio clips.

Related Topics:

- *Utility / DIO port pin configuration on page 12*

Capture setup files

Capture setup files contain data capture setup information from the Capture Settings window. Once a data capture is set up for a particular application, the settings can be saved to a capture setup file for later recall. These files can greatly decrease the amount of time spent on setting up captures before measurement.

It may be helpful to create a library of capture setup files for commonly used measurement configurations. Additionally, capture setup files are portable, so they can be shared with other TMX units.

Saving capture setup files

- 1 Choose File >> Save >> Capture. The Select File window will open.

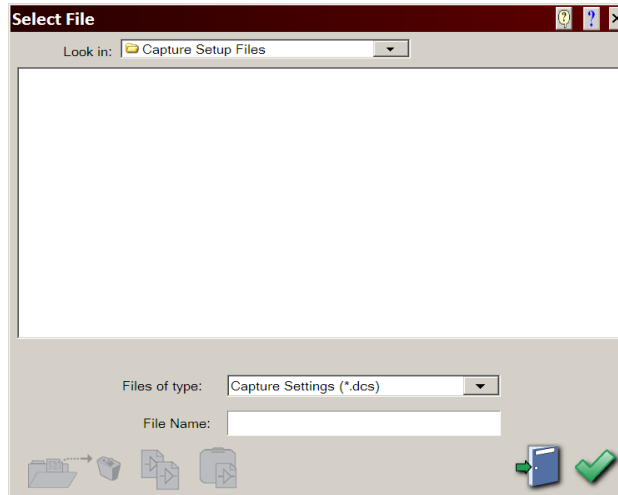

- 2 Choose a destination for the capture setup file. By default, the file will be saved on the system drive (C) in the selected folder. If necessary, you can save the file in a different location by choosing the folder list and browsing to a folder.
- 3 Choose the File Name field. A keypad will appear. Enter a file name and choose OK. The specified file name will appear in the field.
- 4 Choose OK.

Loading capture setup files

- 1 Choose File >> Load >> Capture. The Select File window will open.

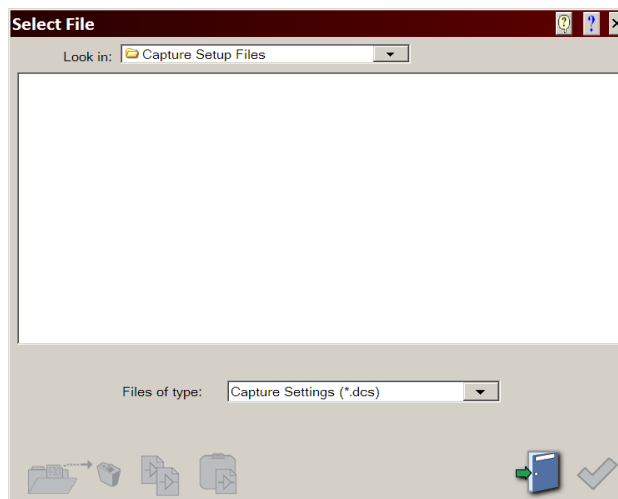

- 2 Select a capture setup file to load. By default, files in the default location on the system drive (C) will be displayed. If necessary, you can select a file from a different location by choosing the folder list and browsing to a folder. Choose OK.

Loading capture setup files with the control panel

You can use control panel icons to quickly load capture setup files.

- 1 Add the capture setup file icon to the control panel.

Choose Settings >> Control Panel to open the Panel Settings window.

Choose the File button. A sub menu will appear. Choose Capture. The Select File window will open.

Select a capture setup file and choose OK. An icon for the selected file will be added to the control panel. Choose OK.



- 2 Load the capture setup file from the control panel by choosing the appropriate capture setup file icon.

Trigger setup files

Trigger setup files contain all setup information from the Trigger Settings window. Once triggers are set up for a particular application, the settings can be saved to a trigger setup file for later recall. These files can greatly decrease the amount of time spent on setting up triggers before measurement.

It may be helpful to create a library of trigger setup files for commonly used measurement configurations. Additionally, trigger setup files are portable, so they can be shared with other TMX units.

Saving trigger setup files

- 1 Open the Select File window using one of the following methods.
 - Choose File >> Save >> Trigger.
 - Choose Capture >> Trigger/Abort Settings. The Trigger Settings window will open. Choose the Save Settings to File icon.



The Select File window will open.

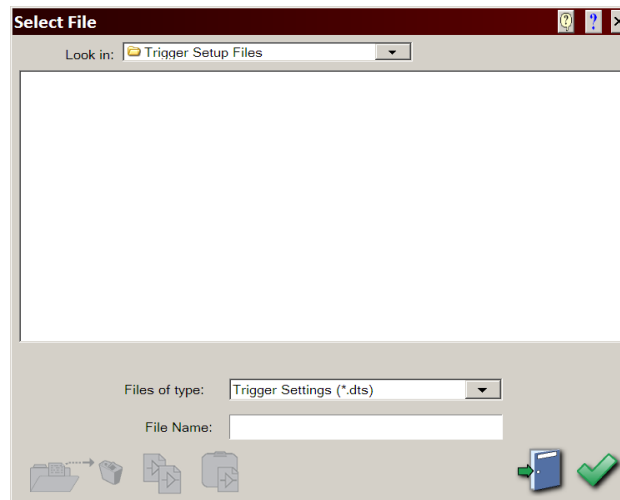

- 2 Choose a destination for the trigger setup file. By default, the file will be saved on the system drive (C) in the selected folder. If necessary, you can save the file in a different location by choosing the folder list and browsing to a folder.
- 3 Choose the File Name field. A keypad will appear. Enter a file name and choose OK. The specified file name will appear in the field.
- 4 Choose OK.

Loading trigger setup files

- 1 Open the Select File window using one of the following methods.
 - Choose File >> Load >> Trigger.
 - Choose Capture >> Trigger/Abort Settings. The Trigger Settings window will open. Choose the Load Settings from File icon.



The Select File window will open.

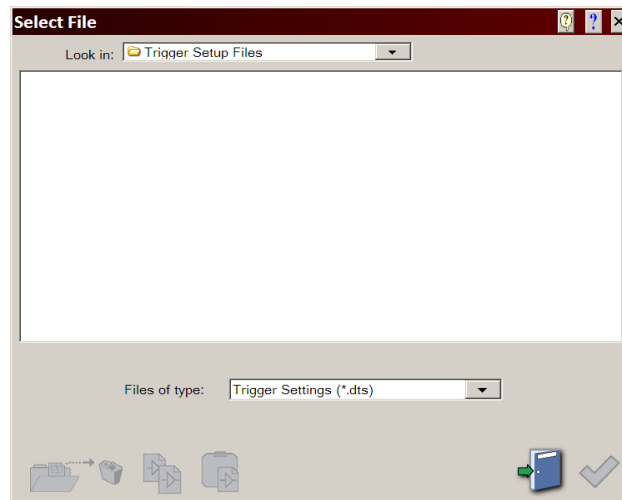

- 2 Select a trigger setup file to load. By default, files in the default location on the system drive (C) will be displayed. If necessary, you can select a file from a different location by choosing the folder list and browsing to a folder. Choose OK.

Loading trigger setup files with the control panel

You can use control panel icons to quickly load trigger setup files.

- 1 Add the trigger setup file icon to the control panel.

Choose Settings >> Control Panel to open the Panel Settings window.

Choose the File button. A sub menu will appear. Choose Trigger. The Select File window will open.

Select a trigger setup file and choose OK. An icon for the selected file will be added to the control panel. Choose OK.



- 2 Load the trigger setup file from the control panel by choosing the appropriate trigger setup file icon.

Formatting the data capture drive

Records can be removed from the data capture drive by performing a format of the drive. This procedure applies to the data capture drive only; it does not affect the system (Windows) drive.

Caution: Use caution when formatting the data capture drive because all data files are deleted. Ensure you have archived any needed files prior to formatting.

- 1 Choose Capture >> Settings. The Capture Settings window will open.

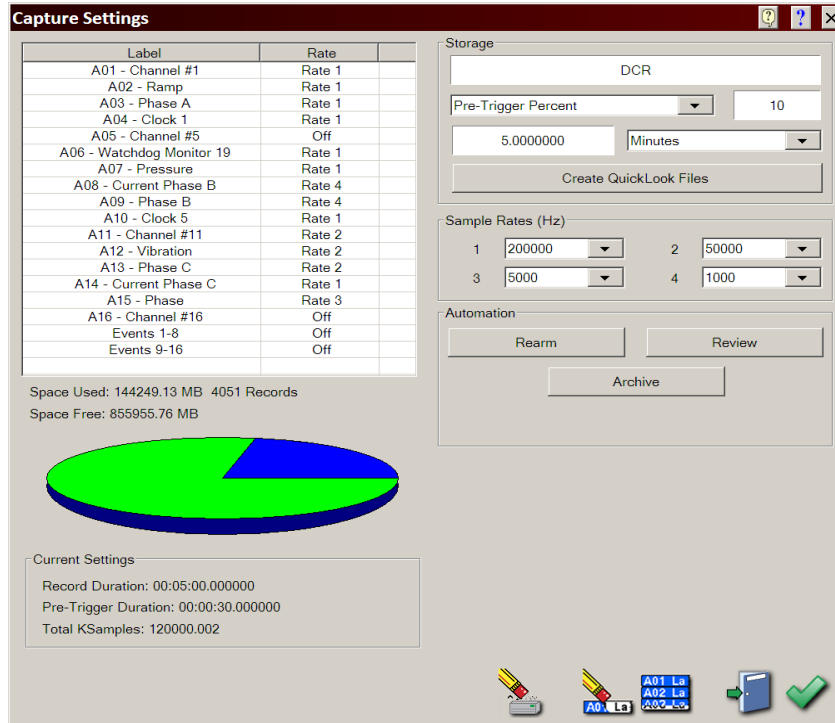

- 2 Choose the Format Capture Disk button.



The Format Capture Drive window will open.

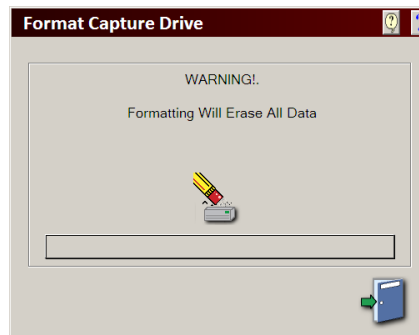

- 3 Choose the Format Drive button.



A confirmation message will appear. Choose OK. The data capture drive will be formatted

10

Scope mode

Scope mode introduction

Scope mode acts like a digital storage oscilloscope, providing high time-base resolution for viewing high-frequency signals. Scope mode is useful for timing and synchronization analysis, transient capture, and high-speed testing. It can be used while continuously capturing data and monitoring signals on the display.

Accessing Scope mode

- 1 Choose Configuration >> Scope from the menu bar. Scope mode will start.

The following illustration displays a typical Scope mode screen. Scope mode screen appearances will vary based on the control panel configuration and other selected options.

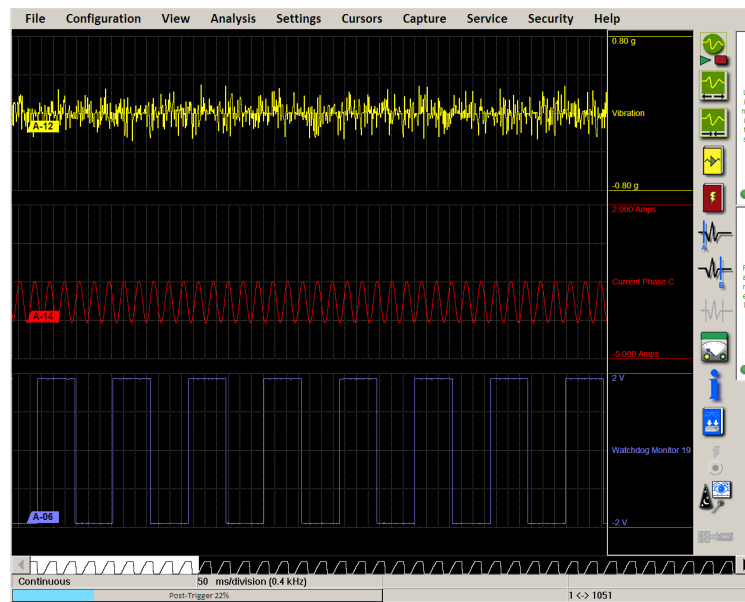

Using the track view

The track view is a visual scroll bar located on the bottom of the display. It can be used to navigate to other areas of the capture.



The track view displays a signal for a visual reference. The signal displayed in the track view can be changed, if desired. If the track view signal is changed, the selected signal will become the default until another signal is chosen.

- 1** Navigate through a file using the track view.
 - To scroll slowly through the file in a particular direction, choose one of the arrows on the sides of the track view.
 - To scroll quickly through the file in a particular direction, press and hold the shaded portion of the track view. Then drag it to the new location and release it. The file will scroll as the shaded bar is dragged.
- 2** If necessary, edit track view settings by choosing View >> Track View Channel. The TrackView Settings window will open.

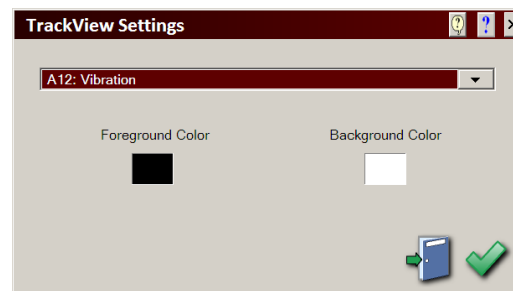

- Select a channel or event to display in the track view.
 - To select a track view foreground color, choose the Foreground Color box. The Color window will open. Select a color and choose OK.
 - To select a track view background color, choose the Background Color box. The Color window will open. Select a color and choose OK.
- 3** Choose OK.

Displaying the trigger line

The trigger line is a vertical line drawn on the display that represents the trigger point of a capture. Use the following instructions to display the trigger line.

- 1** Choose View >> Show Trigger Line. The trigger line will be displayed.

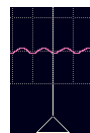

- 2** To hide the trigger line, repeat this process.

Displaying channel IDs

Channel IDs are small visual indicators that identify channels. This feature is especially helpful for identifying multiple signals displayed in a capture.

- 1 Choose View >> Show Channel IDs. Channel IDs will be displayed.











- 2 To hide channel IDs, repeat this process.

Scope mode default control panel

The following list describes the functions of default control panel icons.

Note: A selection path for each icon is indicated. When the Panel Settings window is open, you can use this path to add the icon to the control panel.

Icon	Description
	Scope Arm/Abort arms and aborts scope captures. <i>Settings >> Arm/Abort</i>
	Channel Settings opens the Channel Settings window, which is used to set up amplifier inputs, base channels, derived channels, and event inputs. <i>Settings >> Channels</i>
	Trigger Settings opens the Trigger Settings window, which is used to set up data capture triggers and aborts. <i>Capture >> Trigger/Abort Settings</i>
	Cursor A displays and hides cursor A. <i>Cursors >> Cursor A</i>
	Cursor B displays and hides cursor B. <i>Cursors >> Cursor B</i>
	Move Cursor Left moves the active cursor(s) to the left each time the icon is pressed. <i>Cursors >> Move Left</i>
	Move Cursor Right moves the active cursor(s) to the right each time the icon is pressed. <i>Cursors >> Move Right</i>
	Trigger Indicator indicates when a trigger occurs by displaying a yellow circle. <i>Capture >> Trigger Indicator</i>

Icon	Description
	<p>Capture Indicator indicates when a data capture is in progress by illuminating. <i>Capture >> Capture Indicator</i></p>

Scope captures

A scope capture is a high-speed snapshot of channel information. Every time you view data in Scope mode, you are viewing a scope capture. Scope captures are somewhat similar to data captures, and share much of the same terminology. For example, the concepts of arming, triggering, and aborting apply to scope captures as well as data captures.

Setting up a scope capture

- 1 If triggers or aborts will be used, set them up using the Trigger Settings window (Capture >> Trigger/Abort Settings).

Note: *The trigger/abort setup process for scope captures is identical to the trigger/abort setup process for data captures.*

- 2 Choose Settings >> Scope. The Scope Settings window will open.

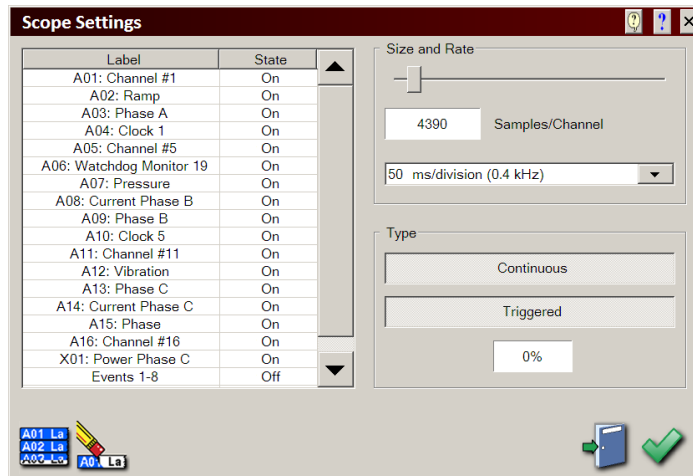

- 3 You can choose from four different types of captures by selecting various combinations of the Continuous and Triggered options.
- **One-Shot** - Perform a one-time scope capture without using a trigger. (Select neither option)
 - **Continuous** - Perform multiple scope captures without using a trigger. (Select the Continuous option)
 - **Triggered One-Shot** - Perform a one-time scope capture that is initiated by a trigger. (Select the Triggered option)
 - **Triggered Continuous** - Perform continuous scope captures that are initiated by a trigger. (Select the Triggered and Continuous options)

Note: You can later change the capture type by choosing the Scope mode status bar along the bottom of the display.



- 4 If the Triggered option is enabled, specify a pre-trigger percentage by selecting the percentage field. A number pad will appear. Enter the percentage of the scope capture to record before the trigger and choose OK.
- 5 Select the channels to include in the scope capture. You can add or remove a channel from the capture by highlighting it, selecting the State column heading, and choosing On or Off.
- 6 Select a size for the scope capture by using the size slider bar. The currently selected number of samples will be displayed just below the slider. The maximum number of samples available will decrease as more channels are included in the capture.

For an alternative method of selecting scope capture size, choose the Samples/Channel field. A number pad will appear. Enter the number of samples to include and choose OK.

Scope capture size is based on the number of samples in the capture. If the scope capture exceeds the display size, a scrolling track view bar will appear on the bottom of the screen.

- 7 Select a time base from the drop-down list. The time base is specified in units of ms/Division or us/Division.

Note: You can later change the time base by choosing the Scope mode status bar along the bottom of the display.

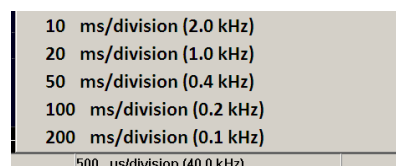

- 8 Choose OK.

Related Topics:

- *Setting up a data capture on page 100*

Performing a scope capture

Scope captures are initiated using a similar process as data captures. The system is armed, pre-trigger data is collected (if triggers are used), a trigger occurs, and data is recorded until the capture is complete or aborted.

- 1 Set up the scope capture.
- 2 Arm the scope capture using the control panel or status bar.
 - To use the control panel, choose the Scope Arm/Abort icon.



- To use the status bar along the bottom of the display, choose the Arm option.



- 3 The next system action depends on the type of scope capture being recorded. The following list describes the sequence of events for each scope capture type:
 - **One-Shot** - A one-time scope capture will occur and display when the scope capture is armed.
 - **Continuous** - Scope captures will occur and display continuously when the scope capture is armed.
 - **Triggered One-Shot** - The system will acquire pre-trigger data until all of the requested pre-trigger storage allocation is filled. When a trigger occurs, a one-time scope capture will occur and display.
 - **Triggered Continuous** - The system will acquire pre-trigger data until all of the requested pre-trigger storage allocation is filled. When a trigger occurs, a

scope capture will occur and display. After each trigger, this process will be repeated.

- 4 To abort a scope capture, use the control panel or status bar.
 - To use the control panel, choose the Scope Arm/Abort icon.



- To use the status bar along the bottom of the display, choose the Arm option.



The currently running scope capture will be aborted.

Embedded scope captures

Embedded scope captures allow you to save trend data at low sample rates while capturing transients at high sample rates. When you open the trend data capture in Review mode, the embedded scope captures will be viewable.

The following diagram illustrates the embedded scope capture concept. Trigger points initiate scope captures that are embedded into the trend data recording. During trend data review, you can open any of the embedded scope captures for high sample rate analysis.

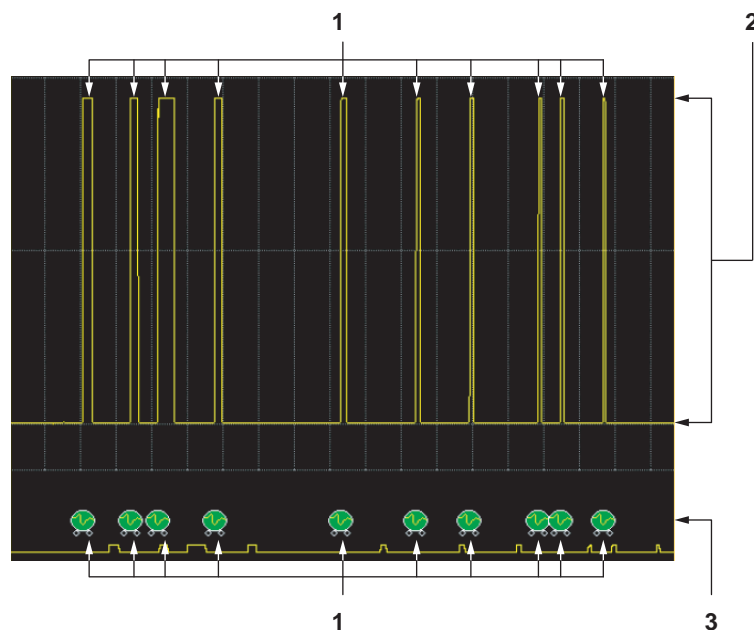

#	Description
1	Transients
2	Trend data (low sample rate)
3	Embedded scope captures (high sample rate)

Setting up embedded scope captures

- 1 Choose Capture >> Settings. The Capture Settings window will open. You will use this window to set up the trend data capture.

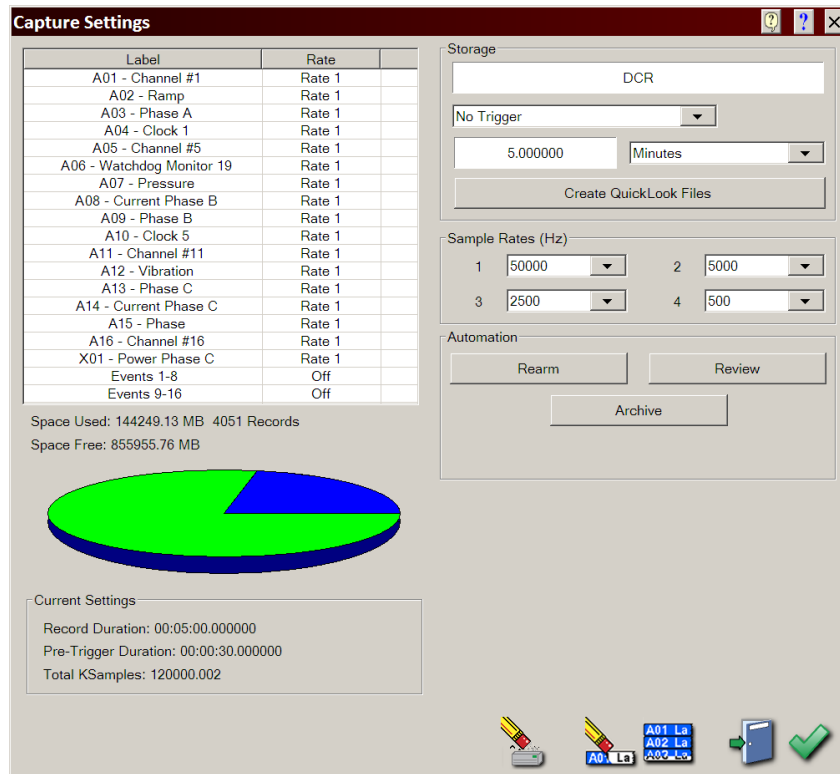

- 2 Select the No Trigger option. Trend data captures do not use pre-trigger recording and they begin when manually armed. Triggers will later be used to initiate scope captures.
- 3 Specify the size of the trend data capture by defining a data capture storage allocation. The size can be defined in units of time (hours, minutes, or seconds) or number of samples (KS/channel).
- 4 Specify sample rates to define the speeds at which trend channels are sampled.
- 5 Select the channels to include in the trend data capture, and the sample rate for each channel.
- 6 Choose OK to complete the trend data capture setup process.

- 7 Choose Capture >> Auto Save Scope with Capture. A check will appear next to this menu option to indicate it is enabled.
- 8 Set up the triggers (and aborts if necessary) using the Trigger Settings window (Capture >> Trigger/Abort Settings).

In the case of embedded scope captures, the triggers are used to capture the high-speed transients and embed them into the slower trend data.

- 9 Choose Settings >> Scope. The Scope Settings window will open. You will use this window to set up scope captures that will be embedded in the trend data.

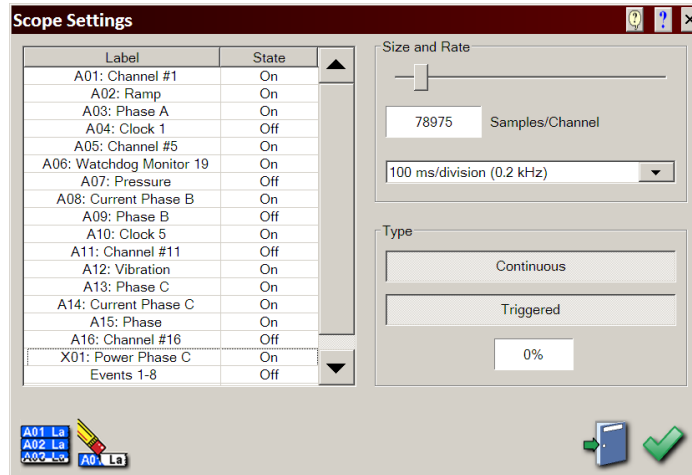

- 10 Select the Triggered and Continuous options.
- 11 Specify a pre-trigger percentage to indicate the percentage of the embedded scope capture to record before a trigger.
- 12 Select the channels to include in the embedded scope captures.
- 13 Select a size for the embedded scope captures by using the size slider bar or Samples/Channel field.
- 14 Select a time base for the embedded scope captures from the drop-down list.
- 15 When you are finished setting up the scope captures, choose OK to close the Scope Settings window.

16 Arm the scope capture using the control panel or status bar.

- To use the control panel, choose the Scope Arm/Abort icon.



- To use the status bar along the bottom of the display, choose the Arm option.



17 Arm the trend data by choosing Capture >> Arm. The trend data will begin recording.

When the trend data meets the specified trigger conditions, a scope capture will be embedded into the trend data.

Related Topics:

- *Setting up a scope capture on page 130*
- *Setting up a data capture on page 100*
- *Triggers and aborts on page 104*

Archiving scope captures

Archiving a scope capture saves the capture (or portions of the capture) to the system drive, a USB storage device, or a network drive. This section provides instructions on archiving scope captures.

Archiving as data capture records in Scope mode

Use the following information to archive as data capture records. This binary format is preferable when using AstroVIEW X on a PC.

- 1 Choose File >> Archive as DCR. A sub menu will appear. Choose whether to archive the entire file, current page, or the area between cursors. The Select File window will open.

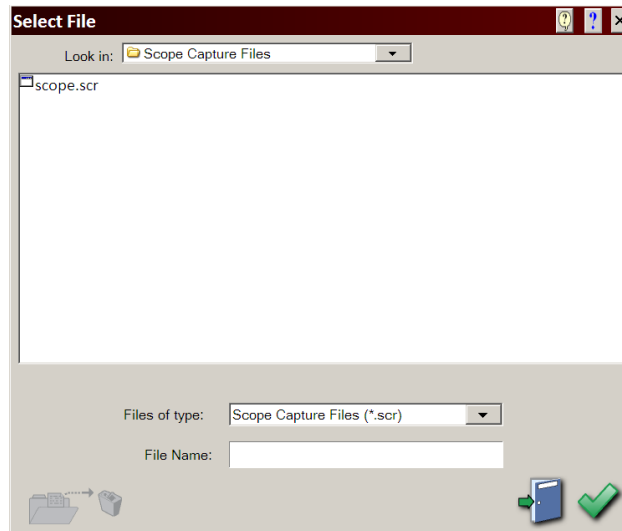

- 2 Choose a destination for the archived scope capture file. By default, the file will be saved on the system drive (C) in the selected folder. If necessary, you can save the file in a different location by choosing the folder list and browsing to a folder. You can archive files to a location on the system drive, a USB storage device, or a network drive.
- 3 Choose the File Name field. A keypad will appear. Enter a file name and choose OK. The specified file name will appear in the field.
- 4 Choose OK.

Review mode introduction

Review mode provides the capability to review and analyze saved data capture and scope capture files. It also provides file management features.

Accessing Review mode

- 1 Choose Configuration >> Review from the menu bar. A file selection window will open.

Note: You can use Review mode while a data capture is in progress.

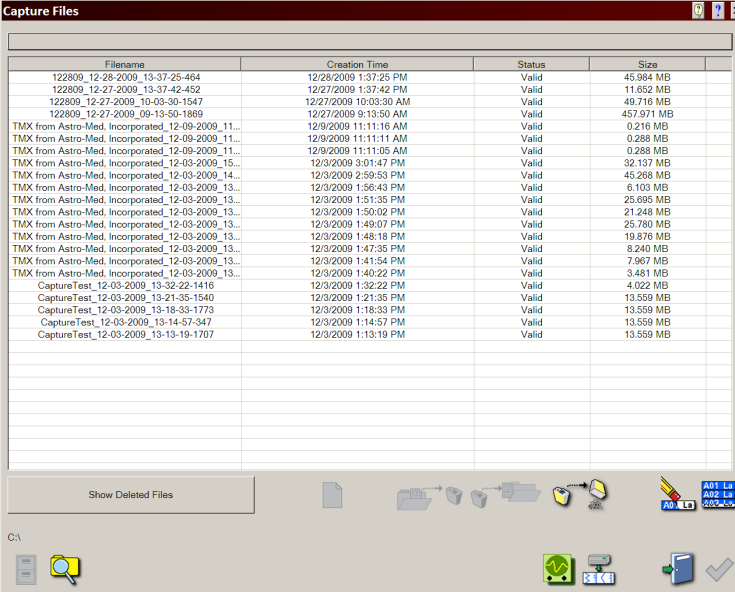

Filename	Creation Time	Status	Size
122809_12-28-2009_13-37-25-464	12/28/2009 1:37:25 PM	Valid	45,984 MB
122809_12-27-2009_13-37-42-452	12/27/2009 1:37:42 PM	Valid	11,602 MB
122809_12-27-2009_10-03-30-1547	12/27/2009 10:03:30 AM	Valid	49,716 MB
122809_12-27-2009_09-13-50-1869	12/27/2009 9:13:50 AM	Valid	457,971 MB
TMX from Astro-Med, Incorporated_12-09-2009_11...	12/9/2009 11:11:16 AM	Valid	0,216 MB
TMX from Astro-Med, Incorporated_12-09-2009_11...	12/9/2009 11:11:11 AM	Valid	0,288 MB
TMX from Astro-Med, Incorporated_12-09-2009_11...	12/9/2009 11:11:05 AM	Valid	0,288 MB
TMX from Astro-Med, Incorporated_12-03-2009_15...	12/3/2009 3:01:47 PM	Valid	32,137 MB
TMX from Astro-Med, Incorporated_12-03-2009_14...	12/3/2009 2:59:53 PM	Valid	45,268 MB
TMX from Astro-Med, Incorporated_12-03-2009_13...	12/3/2009 1:56:43 PM	Valid	6,103 MB
TMX from Astro-Med, Incorporated_12-03-2009_13...	12/3/2009 1:51:35 PM	Valid	25,695 MB
TMX from Astro-Med, Incorporated_12-03-2009_13...	12/3/2009 1:50:02 PM	Valid	21,248 MB
TMX from Astro-Med, Incorporated_12-03-2009_13...	12/3/2009 1:49:07 PM	Valid	25,780 MB
TMX from Astro-Med, Incorporated_12-03-2009_13...	12/3/2009 1:48:18 PM	Valid	19,876 MB
TMX from Astro-Med, Incorporated_12-03-2009_13...	12/3/2009 1:47:35 PM	Valid	8,240 MB
TMX from Astro-Med, Incorporated_12-03-2009_13...	12/3/2009 1:41:54 PM	Valid	7,967 MB
TMX from Astro-Med, Incorporated_12-03-2009_13...	12/3/2009 1:40:22 PM	Valid	3,481 MB
CaptureTest_12-03-2009_13-32-22-1416	12/3/2009 1:32:22 PM	Valid	4,022 MB
CaptureTest_12-03-2009_13-21-35-1540	12/3/2009 1:21:35 PM	Valid	13,559 MB
CaptureTest_12-03-2009_13-16-33-1773	12/3/2009 1:16:33 PM	Valid	13,559 MB
CaptureTest_12-03-2009_13-14-57-347	12/3/2009 1:14:57 PM	Valid	13,559 MB
CaptureTest_12-03-2009_13-13-19-1707	12/3/2009 1:13:19 PM	Valid	13,559 MB

This window provides a list of all files stored on the data capture drive.

2 Select a file to analyze in Review mode.

- To open a data capture file from the data capture drive, select a file from the list and choose OK.
- To open an archived data capture file from the system drive, choose the Archived Data Capture icon.



Select an archived data capture file and choose OK.

- To open a scope capture file from the system drive, choose the Scope Capture button.



Select a scope capture file and choose OK.

- To open a file located in a specific folder on the system drive, choose the Browse Folders icon.



Browse to a file and choose OK.

Review mode will start.

The following illustration displays a typical Review mode screen. Review mode screen appearances will vary based on the control panel configuration and other selected options.

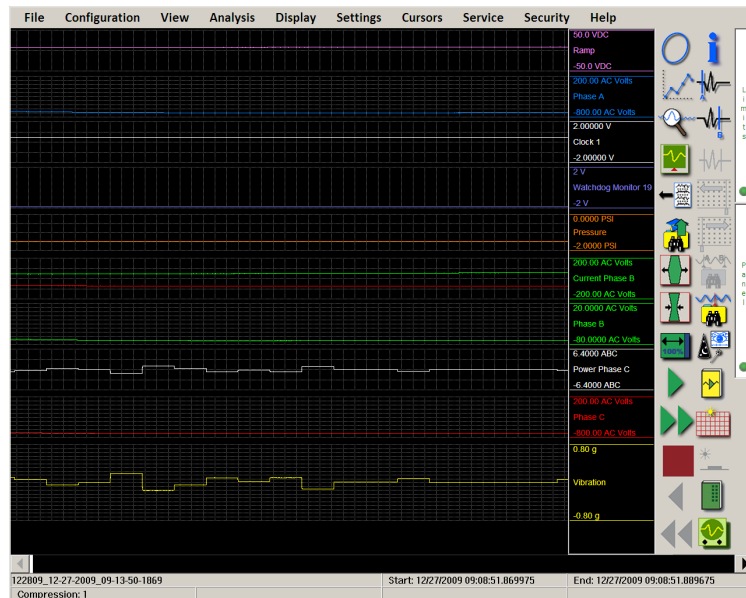

LookBack review

You will typically review data captures after they have been completed. However, in some situations, it may be helpful to review an in-progress data capture. LookBack review allows you to review a data capture as it is written to the data capture drive.

Launch Review mode during a data capture. The in-progress data capture will be indicated as “Active” in the Status column, and the Filename column will indicate the DCR base file name. Select the active data capture and choose OK.

Note: A file must be 8 MB in size before it will become active for LookBack review.

As you review the active capture file, it will continually be updated with new data from the capture. Note that the rate in which it is updated will vary based on your data capture settings.

Note: Once you have opened a file for LookBack review, updates to that file will not be displayed. Only data from the beginning to the point in time when the file was opened will be available for review. To view the latest data, re-open the file.

Loading a new file

- 1 While in Review mode, choose File >> Load New File. A file selection window will open.

Filename	Creation Time	Status	Size
DCR_12-29-2009_11-39-20-1770	12/29/2009 11:39:20 AM	Valid	1.733 MB
DCR_12-29-2009_11-37-24-1873	12/29/2009 11:37:24 AM	Valid	1.733 MB
DCR_12-29-2009_11-14-39-1204	12/29/2009 11:14:39 AM	Valid	1.733 MB
DCR_12-29-2009_10-55-12-1373	12/29/2009 10:55:12 AM	Valid	1.733 MB
DCR_12-29-2009_10-54-59-432	12/29/2009 10:54:59 AM	Valid	0.744 MB
DCR_12-29-2009_10-53-37-601	12/29/2009 10:53:37 AM	Valid	15.466 MB
DCR_12-29-2009_10-53-04-1560	12/29/2009 10:53:04 AM	Valid	12.775 MB
122809_12-28-2009_15-40-05-298	12/28/2009 3:40:05 PM	Valid	27.150 MB
122809_12-29-2009_13-37-25-464	12/28/2009 1:37:25 PM	Valid	45.984 MB
122809_12-27-2009_13-37-42-452	12/27/2009 1:37:42 PM	Valid	11.652 MB
122809_12-27-2009_10-03-30-1547	12/27/2009 10:03:30 AM	Valid	49.716 MB
122809_12-27-2009_09-13-50-1809	12/27/2009 9:13:50 AM	Valid	457.971 MB
TMX from Astro-Med, Incorporated_12-09-2009_11...	12/9/2009 11:11:16 AM	Valid	0.216 MB
TMX from Astro-Med, Incorporated_12-09-2009_11...	12/9/2009 11:11:11 AM	Valid	0.288 MB
TMX from Astro-Med, Incorporated_12-09-2009_11...	12/9/2009 11:11:05 AM	Valid	0.288 MB
TMX from Astro-Med, Incorporated_12-03-2009_15...	12/3/2009 3:01:47 PM	Valid	32.137 MB
TMX from Astro-Med, Incorporated_12-03-2009_14...	12/3/2009 2:59:53 PM	Valid	45.268 MB
TMX from Astro-Med, Incorporated_12-03-2009_13...	12/3/2009 1:56:43 PM	Valid	6.193 MB
TMX from Astro-Med, Incorporated_12-03-2009_13...	12/3/2009 1:51:35 PM	Valid	25.695 MB
TMX from Astro-Med, Incorporated_12-03-2009_13...	12/3/2009 1:50:02 PM	Valid	21.248 MB
TMX from Astro-Med, Incorporated_12-03-2009_13...	12/3/2009 1:49:07 PM	Valid	25.780 MB
TMX from Astro-Med, Incorporated_12-03-2009_13...	12/3/2009 1:48:18 PM	Valid	19.376 MB
TMX from Astro-Med, Incorporated_12-03-2009_13...	12/3/2009 1:47:35 PM	Valid	8.240 MB
TMX from Astro-Med, Incorporated_12-03-2009_13...	12/3/2009 1:41:54 PM	Valid	7.967 MB
TMX from Astro-Med, Incorporated_12-03-2009_13...	12/3/2009 1:40:22 PM	Valid	3.481 MB
CaptureTest_12-03-2009_13-32-22-1416	12/3/2009 1:32:22 PM	Valid	4.022 MB
CaptureTest_12-03-2009_13-21-35-1540	12/3/2009 1:21:35 PM	Valid	13.559 MB
CaptureTest_12-03-2009_13-18-33-1773	12/3/2009 1:18:33 PM	Valid	13.559 MB
CaptureTest_12-03-2009_13-14-57-347	12/3/2009 1:14:57 PM	Valid	13.559 MB
CaptureTest_12-03-2009_13-13-19-1707	12/3/2009 1:13:19 PM	Valid	13.559 MB

- 2 Select a file to open and choose OK.

Related Topics:

- [Accessing Review mode on page 139](#)

Loading the next/previous file

You can quickly open the next or previous file on a specific drive during data capture review.

- 1 Set a sorting preference to determine the file next/previous sequence.
 - From Review mode, choose File >> Load New File to open the Review mode file selection window.
 - From any other mode of operation, choose Configuration >> Review to open the Review mode file selection window.

Choose a column heading to apply a sorting order.

- 2 Open a file for review.
- 3 While reviewing the file, choose File >> Load Next File or Load Previous File to open the next or previous file.

The next/previous file is determined by the last sorting order used in the Review mode file selection window for the drive.

Viewing file information

The File Summary window in Review mode provides additional information about capture files. It displays information including file name, number of samples, sample rates, data capture, and channel amplifier settings.

- 1 Open the File Summary window using one of the following methods.
 - With a file open in Review mode, choose File >> Summary.
 - From the Review mode file selection screen, select a file and choose the Summary button.



Deleting files

- 1 Choose Configuration >> Review from the menu bar. A file selection window will open.

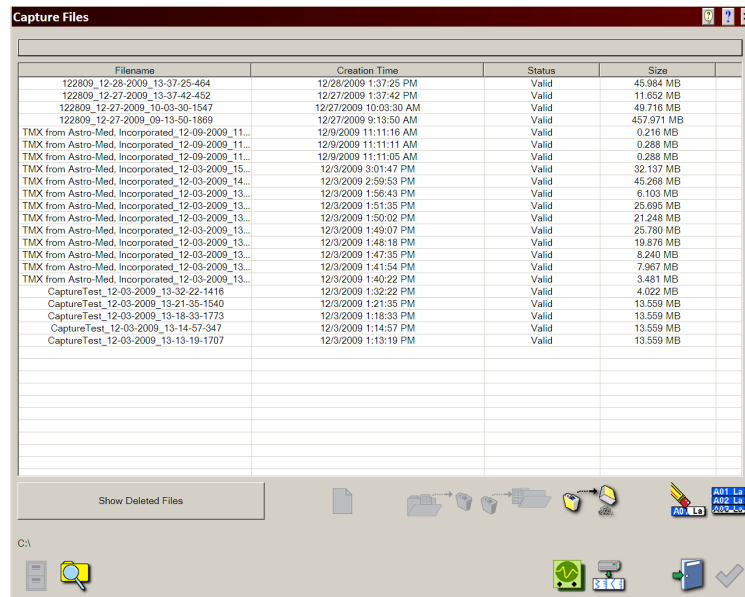

- 2 To send files to the trash, select the files and choose the Send to Trash icon.

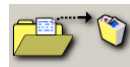

The selected files will be transferred to the trash.

- 3 To retrieve files from the trash, choose the Show Deleted Files button. The file list will be refreshed to display deleted files. Then select the files from the list.

Choose the Retrieve from Trash icon.

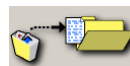

The selected files will be retrieved from the trash.

- 4 To empty the trash and free the space it occupies on the data capture drive, choose the Empty Trash icon.

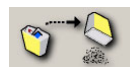











The trash will be emptied.

Note: Emptying the trash permanently deletes all files currently in the trash. Use caution with this feature to ensure that needed files are not deleted. This process can take a significant amount of time. Ensure the unit can be allowed to finish without power interruption to prevent data loss.

Review mode default control panel

The following list describes the functions of default control panel icons.

Note: A selection path for each icon is indicated. When the Panel Settings window is open, you can use this path to add the icon to the control panel.

Icon	Description
	Scroll Fast Back scrolls the chart backward quickly. <i>Display >> Rewind</i>
	Scroll Back scrolls the chart backward. <i>Display >> Scroll Backward</i>
	Scroll Stop stops the chart from scrolling. <i>Display >> Scroll Stop</i>
	Scroll Fast Forward scrolls the chart forward quickly. <i>Display >> Fast Forward</i>
	Scroll Forward scrolls the chart forward. <i>Display >> Scroll Forward</i>
	Cursor A displays and hides cursor A. <i>Cursors >> Cursor A</i>
	Cursor B displays and hides cursor B. <i>Cursors >> Cursor B</i>
	Active Cursor changes the active cursor between A, B, or A & B. <i>Cursors >> Active Cursor</i>
	Move Cursor Left moves the active cursor(s) to the left each time the icon is pressed. <i>Cursors >> Move Left</i>
	Move Cursor Right moves the active cursor(s) to the right each time the icon is pressed. <i>Cursors >> Move Right</i>
	Trigger Line shows and hides the trigger line in the waveform display area. <i>View >> Trigger Line</i>

File scrolling and navigation

This section describes how to use the track view, control panel, and menu bar to scroll and navigate through capture files in Review mode.

Using the track view

The track view is a visual scroll bar located on the bottom of the display. It can be used to navigate to other areas of the capture.



The track view displays a signal for a visual reference. The signal displayed in the track view can be changed, if desired. If the track view signal is changed, the selected signal will become the default until another signal is chosen.

- 1 Navigate through a file using the track view.
 - To scroll slowly through the file in a particular direction, choose one of the arrows on the sides of the track view.
 - To scroll quickly through the file in a particular direction, press and hold the shaded portion of the track view. Then drag it to the new location and release it. The file will scroll as the shaded bar is dragged.
- 2 If necessary, edit track view settings by choosing View >> Track View Channel. The TrackView Settings window will open.

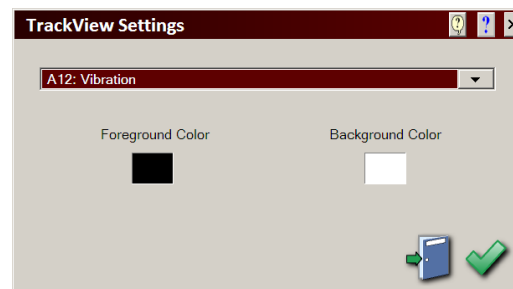

- Select a channel or event to display in the track view.
 - To select a track view foreground color, choose the Foreground Color box. The Color window will open. Select a color and choose OK.
 - To select a track view background color, choose the Background Color box. The Color window will open. Select a color and choose OK.
- 3 Choose OK.

File navigation control panel icons

The default control panel for Review mode provides a variety of buttons to scroll through the file.

Related Topics:

- *Review mode default control panel on page 144*

File navigation menu options

The Display option on the menu bar provides the following methods of navigating through capture files.

- **Goto** scrolls directly to the start, end, trigger point, or cursor location in a file. An advanced search is also available that scrolls based on specified conditions.

- **Page Back** scrolls the chart back one page.
- **Page Forward** scrolls the chart forward one page.
- **Rewind** scrolls the chart backwards quickly.
- **Scroll Back** scrolls the chart backwards.
- **Scroll Stop** stops the chart from scrolling.
- **Scroll Forward** scrolls the chart forward.
- **Fast Forward** scrolls the chart forward quickly.

Many of the navigational features found on the menu bar are also included in the default control panel for Review mode.

Related Topics:

- *Review mode default control panel on page 144*

Using advanced search

- 1 Choose Display >> Goto >> Advanced. The Advanced Search window will open.

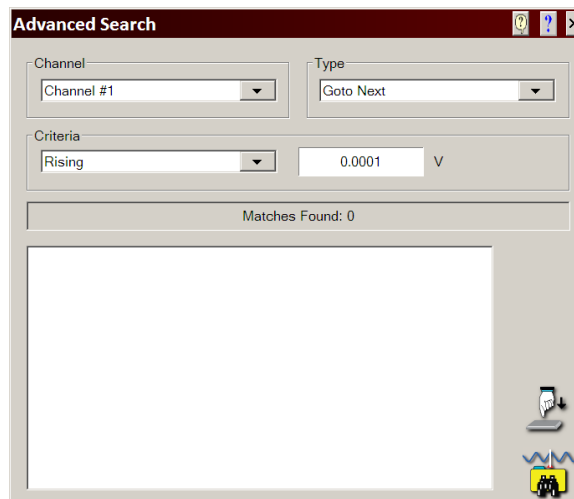

- 2 Select the channel you want to search.
- 3 Select whether to search for rising, falling, or rising and falling voltage levels. Use the corresponding field to enter the voltage to search for.

- 4 Select a search type.
 - **Goto Next** - Searches forward in the file for the next instance of the specified voltage change.
 - **Goto Previous** - Searches backward in the file for the previous instance of the specified voltage change.
 - **Entire Record** - Searches the entire file for all instances of the specified voltage change.
 - **Forward** - Searches forward in the file for all instances of the specified voltage change.
 - **Back** - Searches backward in the file for all instances of the specified voltage change.
 - **Counter** - Searches the entire file and reports the number of instances of the specified voltage change.
- 5 Choose the Apply icon to perform the search. Search results will be displayed in the list.



- 6 To navigate directly to a search result, select it from the list and choose the Find icon.



File compression

Review mode displays files in a horizontally scrolling orientation. The file under review is typically larger than the display area, and scrolling is used to navigate through the file. Compression and expansion options are available to decrease or increase the horizontal size of a file.

Showing all of the file

The contents of a file can be compressed to fit the entire file in the display.

- 1 Choose Display >> Show All File. The file will be compressed to fit on one screen. The amount of compression will be displayed on the bottom of the screen.

Setting a compression

A specific compression ratio can be used to compress the file. The compression ratio is based on a factor of 1 to X, where X is that which will cause the entire file to fit on the display without scrolling. A compression ratio of 1 will result in no compression.

When a file is compressed, more of the entire file will fit on one screen, and less scrolling is necessary to navigate throughout the file.

Note: *Very large data captures may take some time to display if the compression value is high.*

- 1 Choose Display >> Compression. A number pad will appear.
- 2 Enter the desired compression ratio and choose OK. The file will be compressed.

Setting an expansion

A specific expansion ratio can be used to expand the file. The expansion ratio is based on a factor of 1 to 100. An expansion ratio of 1 will result in no expansion, while a ratio of 100 will expand the file by 100 times its original size.

When a file is expanded, less of the entire file will fit on one screen, and more scrolling is necessary to navigate throughout the file.

- 1 Choose Display >> Expansion. A number pad will appear.
- 2 Enter the desired expansion ratio and choose OK. The file will be expanded.

Review mode view options

This section describes how to configure the view and display options of Review mode.

Selecting a status text format

In the lower-right corner of the Review mode screen, a status text area is displayed.

Start: 1	End: 1050
----------	-----------

The type of information displayed in the status text area can be changed.

- 1 Choose View >> Status Text Format. A sub menu will appear.

- 2 Select a status text display option.
 - **Samples** - The sample numbers for the first and last samples displayed on the screen will be shown.
 - **Relative Time** - The times, relative to the start of the data capture, for the first and last samples displayed on the screen will be shown.
 - **Absolute Time** - The times, as recorded by the system clock, for the first and last samples displayed on the screen will be shown.
 - **Percent** - The percentage points, relative to the entire data capture, for the first and last samples displayed on the screen will be shown.

Displaying the trigger line

The trigger line is a vertical line drawn on the display that represents the trigger point of a capture. Use the following instructions to display the trigger line.

- 1 Choose View >> Show Trigger Line. The trigger line will be displayed.

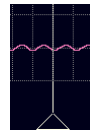

- 2 To hide the trigger line, repeat this process.

Displaying channel IDs

Channel IDs are small visual indicators that identify channels. This feature is especially helpful for identifying multiple signals displayed in a capture.

- 1 Choose View >> Show Channel IDs. Channel IDs will be displayed.

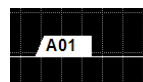

- 2 To hide channel IDs, repeat this process.

Viewing and editing notes

If notes are included in a capture, they can be viewed and edited in Review mode.

- 1 Use the Note Viewer window to access notes in Review mode. There are two ways to open this window.
 - Chose Analysis >> Note Viewer.
 - Any note that was entered during a data capture is marked with a pencil icon at the bottom of the Review mode screen. Choose a pencil icon to open the Note Viewer window and display the selected note.



- 2 Review and edit notes with the Note Viewer window.



- Use the scroll bar on the top of the window to toggle which note in the file is displayed.
- To scroll directly to the displayed note's location in the file, choose the Go To Location icon.



- To edit the note, choose the Edit icon. A keypad will appear. Edit the note and choose OK.



Adding notes

You can add notes to files in Review mode.

- 1 Choose Analysis >> Add Note. A sub menu will appear. Choose whether to add the note at the center of the screen or a cursor location. A keypad will appear.
- 2 Enter the note text and choose OK. The note will be saved as part of the capture file.

Playing audio

If audio notes are included in a data capture, you can play them in Review mode.

The recorder has an internal speaker that is used for audio playback. As an alternative, you can use headphones or external speakers connected to the recorder's audio jacks.

Note: You can access the audio files for archived data captures by browsing to the folder associated with the data capture using Windows Explorer (for example, C:\TMX\Data Capture Files\DCR folder).

- 1 If you will use optional headphones or external speakers, plug them into to the appropriate audio jack on the side of the recorder.

Note: When you plug a device into an audio jack, an audio control window may open to allow configuration of the device. Leave the default settings unchanged and choose OK twice to close this window. If you need additional assistance with this window, please contact Technical Support.

- 2 Use the Audio Note Viewer window to access audio notes in Review mode. There are two ways to open this window.
 - Chose Analysis >> Audio Note Viewer.
 - Any audio note that was entered during a data capture is marked with a speaker icon at the bottom of the Review mode screen. Choose a speaker icon to open the Audio Note Viewer window and select the current note.



- 3 Play audio with the Audio Note Viewer window.

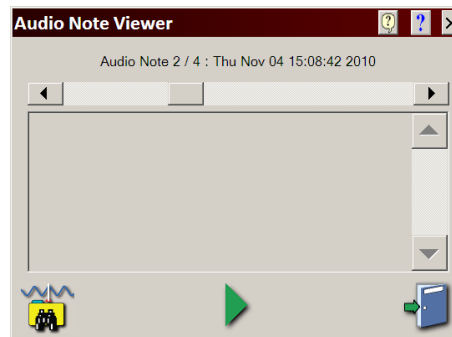

- Use the scroll bar on the top of the window to toggle which audio note in the file is selected.
- To play the audio note, choose the Play icon.



- To scroll directly to the selected audio note's location in the file, choose the Go To Location icon.



Viewing embedded scope captures

If embedded scope captures are included in a capture, they can be viewed in Review mode. You can view embedded scope captures in a window within Review mode, or in the full Review mode screen itself.

- To view embedded scope captures in the Scope Viewer window**, choose Settings >> Scope Viewer >> Viewer. Then choose Analysis >> Scope Viewer to open the Scope Viewer window.

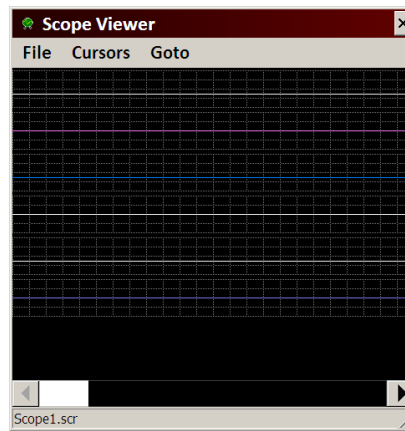

As an alternate method of opening embedded scope captures, scroll to and choose a scope icon in the file.



- If necessary, choose the Cursors menu option to use cursors. The cursors in this window function similar to cursors in other functions.
- If necessary, choose Goto >> Scope Location from the menu to scroll to the scope location in the file.
- If necessary, move to the next or previous scope capture in the file by choosing File >> Load Next File or Load Previous File.
- Choose the X in the upper-right corner to close the Scope window.

- To view embedded scope captures in the full Review mode screen**, choose Settings >> Scope Viewer >> Full Screen. Then choose Analysis >> Scope Viewer to review the embedded scope captures.

As an alternate method of opening embedded scope captures, scroll to and choose a scope icon in the file.



- While reviewing an embedded scope capture in the Review mode screen, the Show Next File and Show Previous File functions can be used to navigate to other embedded scope captures in the current data capture.
- When you are finished reviewing the embedded scope capture, choose File >>

Return to DCR, or the Return to DCR control panel button, to close the scope capture and return to the original data capture file.



Viewing video during review

If a data capture contains video recorded with the TMX-VA option, you can view the video recording in Review mode.

Note: For information about adding the TMX-VA option to your system, please contact Test & Measurement Sales.

- 1 Choose View >> Video.

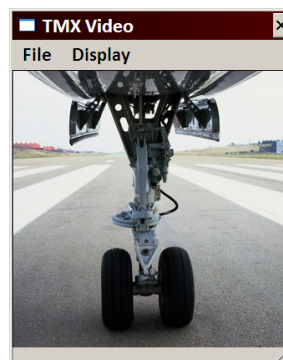

- 2 Review the video. As you review the data file, the video will play synchronized to the activity in the data capture. Each video frame is associated with a sample number.
- 3 You can change the location of the video reference point by choosing Display >> Sample and choosing from the following options.
 - **Cursor A** - Choose this option to associate the video with the sample at cursor A.
 - **Cursor B** - Choose this option to associate the video with the sample at cursor B.
 - **Rightmost Sample** - Choose this option to associate the video with the rightmost sample on the display.

Saving the Review mode view as default

When you open a file in Review mode, the view will be the same as when the file was captured. You can modify the view and save it as the default for future review sessions with that file.

- 1 Choose File >> Save View as Default. The view will be saved.

The next time the current file is opened in Review mode, this saved view will be used.

Review mode channel setup

This section describes how to modify channel settings for files during review.

Review Channel Settings window overview

The Review Channel Settings window (Settings >> Channels) is used to set up channels and events in Review mode. The Review Channel Settings window provides two layout options.

- **List view** - You can change settings in list view by selecting a channel and choosing the column heading for the setting you want to change. Some options can be configured for a group of channels at the same time by selecting a group of channels prior to choosing a column heading. In this case, setup information will be applied to all selected channels.

Some options must be configured for each channel individually, or in groups based on compatible channels.

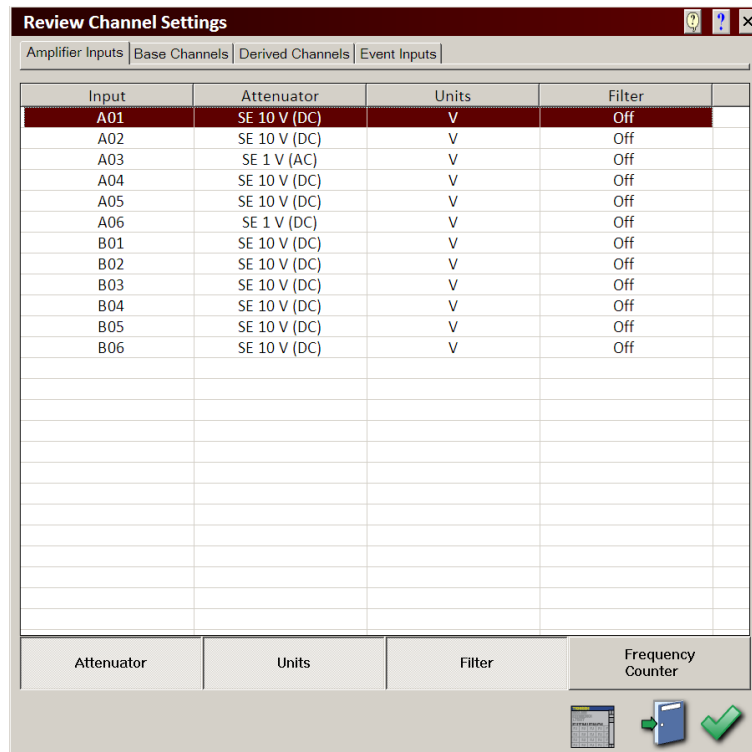

Use the buttons below the list to display other columns.

- **Graphical view** - You can change settings in graphical view by selecting a single channel and the appropriate options for the channel.

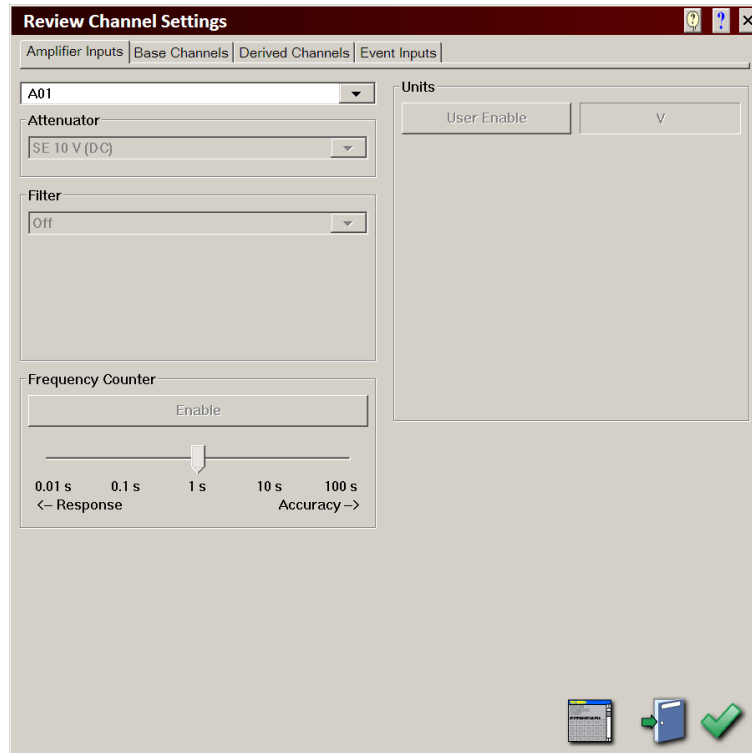

You can switch between list view and graphical view by choosing the Toggle Layout icon.



Some items in the Review Channel Settings window cannot be changed. The following items are saved as part of a data capture and cannot be edited in Review mode.

- Amplifier Inputs - Items in this tab cannot be modified.
- Base Channels - Top/Bottom and Center/Span settings cannot be modified.

Setting up Review mode filters

Filters are used to reduce the amplitude of certain waveforms based on their frequency. This allows you to restrict your data to certain frequencies and exclude extraneous data. Two types of filters are available.

- **Amplifier input filters** are hardware based and affect the input data before it is captured. These filters are permanent and cannot be undone once the data is captured.
- **Review mode filters** are software based and affect how the data is viewed in Review mode. They temporarily modify the view without altering the captured data.

This section describes how to set up Review mode filters.

- 1 Choose Settings >> Channels. The Review Channel Settings window will open. Choose the Base Channels tab.

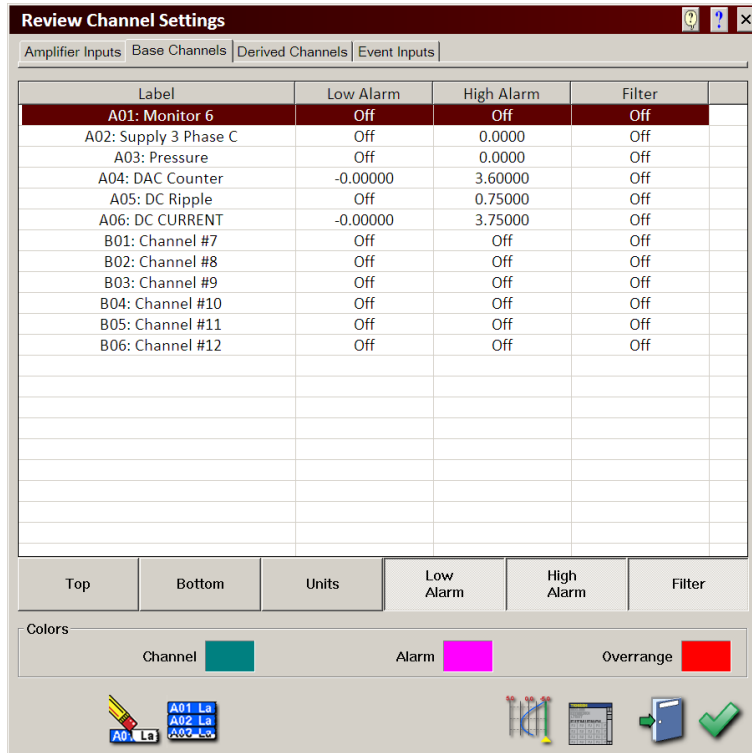

- 2 Select the channel or channels to apply a filter to. Note that more than one channel can be selected at a time. Any changes made will affect all selected channels.
- 3 Choose the Filter column heading. The Review mode Filter window will open.

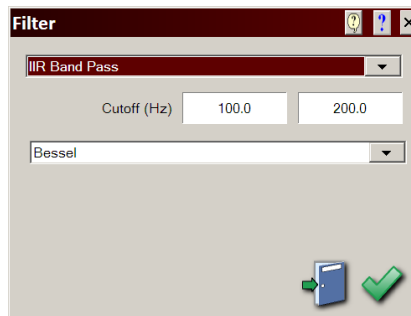

- 4 Select an **IIR** (Infinite Impulse Response) or **FIR** (Finite Impulse Response) filter type.
 - IIR filters perform faster, and are generally easier to construct, but can suffer from non-linear phase response.
 - FIR filters have a known, linear phase response. This allows the phase change that results from filtering to be easily compensated for. The drawback is that

they require more resources for similar frequency responses in smaller IIR filters.

The following filter types are available.

- **Low Pass** - Filters out frequencies above a specified cutoff point.
- **High Pass** - Filters out frequencies below a specified cutoff point.
- **Band Pass** - Creates a window based on two specified cutoff points, identified as upper and lower frequency boundaries. Anything outside this window is excluded.
- **Band Stop** - Creates a window based on two specified cutoff points, identified as upper and lower frequency boundaries. Anything inside this window is excluded.

5 Select a filter topology.

- **Bessel** filters are typically characterized by a nearly linear phase response in the pass band. They are commonly used in applications where little phase distortion is required. The trade off for this is a gentler roll off around the cutoff frequency.
- **Butterworth** filters produce the most “ideal” response, generating maximum flatness and unity gain in the pass band, and monotonic decrease of frequency after the cutoff.
- **Chebyshev** filters feature the sharpest transition band, but will have gain ripple in the pass band. A 4th order Chebyshev with 3 db of ripple, for instance, will drop at 100 db per decade.

If the Chebyshev topology is used, the Ripple field will appear. Enter a desired ripple value from 0.1 to 10.0 into this field.

6 Enter a cutoff frequency. The available range of this value will vary, depending on the current filter type. If the Band Pass or Band Stop filter types are used, you’ll need to enter two cutoff frequencies; an upper boundary and a lower boundary.

Setting a cutoff value to 500 Hz or greater will result in a 4th order filter; a cutoff of less than 500 Hz will result in a 1st order filter.

7 Choose OK.

Related Topics:

- *Setting up amplifier input filters on page 62*

Review mode derived channels

Derived channels are saved as part of data captures, however, derived channel data is not saved directly. Instead, the following items are saved.

- The derived channel equation
- The channels that are used in the derived channel equation

This allows you to review derived channels and modify their equations during review. You can also create new derived channels based on channels in the capture.

Note: *If you modify derived channel equations in Review mode, and then use the Save Channels as Default feature, the original equations will be overwritten.*

Related Topics:

- *Derived channels on page 70*
- *Saving the Review mode channels as default on page 158*

Saving the Review mode channels as default

When you open a file in Review mode, the channel settings will be the same as when the file was captured. You can modify the channel settings and save them as the default for future review sessions with that file.

- 1 Choose File >> Save Channels as Default. The channel settings will be saved.

The next time the current file is opened in Review mode, the saved channel settings will be used.

Archiving files in Review mode

Archiving a file copies the file (or portions of the file) from the data capture drive to the system drive, a USB storage device, or a network drive. Once files are archived, they can be copied, moved, and deleted using the Microsoft® Windows operating system. Additionally, files must be archived in order to access them via Ethernet from a PC.

Note: *Archiving files does not remove them from the data capture drive.*

Archiving as data capture records in Review mode

Use the following information to archive as data capture records. This binary format is preferable when using AstroVIEW X on a PC.

Note: *Files can also be archived as data capture records in the file selection window prior to accessing Review mode. Choose the folder icon to select an archive location. Then select the files*

to archive and choose the file cabinet icon button. This method is helpful for archiving multiple files at the same time.

- 1 Choose File >> Archive as DCR. A sub menu will appear. Choose whether to archive the entire file, current page, or the area between cursors. The Select Folder window will open.

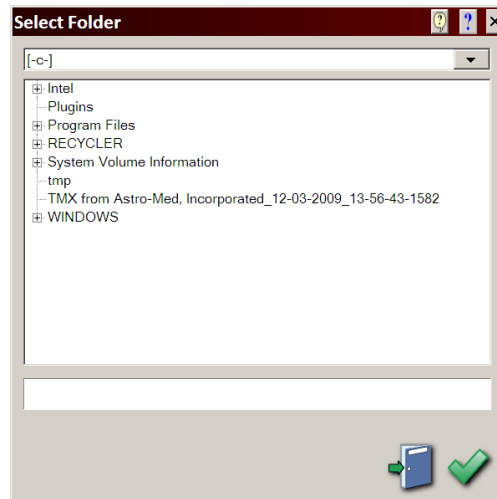

- 2 Select an archive drive with the drop-down list. A folder list will appear. You can archive files to a location on the system drive, a USB storage device, or a network drive. Browse to the archive folder and choose OK. A keypad will appear.
- 3 Enter a name for the archive file and choose OK. The archive file will be saved.

12

Analysis tools

Cursors

Cursors can be used to measure channels in Realtime, Scope, and Review modes. They are used in conjunction with the Channel Information window to view a variety of measurements.

Measuring channels with cursors

- 1 Show one or both of the cursors by choosing Cursors >> Show Cursor A and/or Cursors >> Show Cursor B from the menu bar.

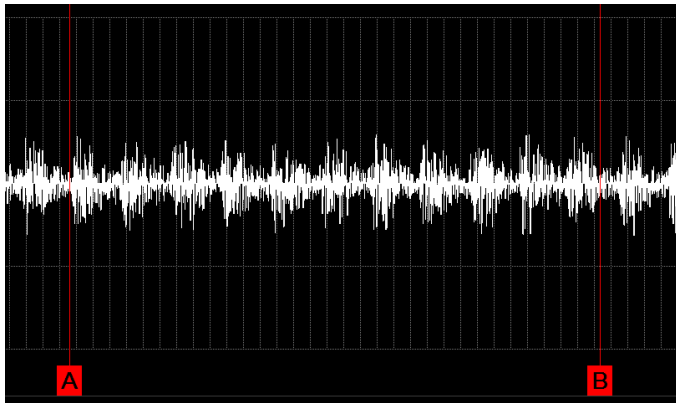

- 2 Choose Analysis >> Channel Information to open the Channel Information window.

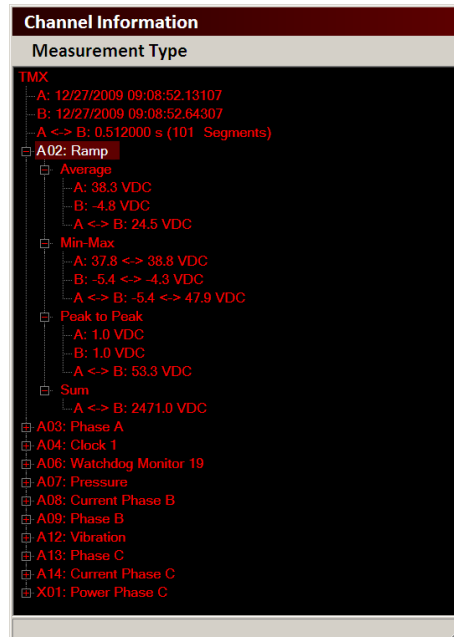

The Channel Information window displays the waveform values at each cursor based on the current measurement type.

- 3 Choose the Measurement Type menu option. Select a measurement type from the list.
 - **Average** displays the midpoint value of the data represented by the cursor. When using two cursors, it displays the average of the midpoint values of the data between cursors A and B (including cursor data).
 - **Minimum-Maximum** displays the maximum and minimum signal values of the data represented by the cursor. When using two cursors, it displays the maximum and minimum signal values represented by the data between cursors A and B (including cursor data).
 - **Peak-Peak** displays the difference between the maximum and minimum signal measurements between cursors A and B (including cursor data). This measurement is available only when both cursors are displayed.
 - **Slope** uses linear regression of the average of the maximum and minimum of each point between cursors A and B (including cursor data) to create a line

which best represents the data. This measurement is available only when both cursors are displayed.

- **RMS** displays the square root of the sum of squares divided by the number of samples between cursors A and B (including cursor data). This measurement is available only when both cursors are displayed.
- **Sum** displays the sum of the average of the maximum and minimum of each point between cursors A and B (including cursor data). This measurement is available only when both cursors are displayed.
- **Sum of Squares** displays the sum of the average of the maximum and minimum signal values represented by the data between cursors A and B (including cursor data) squared. This measurement is available only when both cursors are displayed.
- **Variance** measures how the set of data between cursors A and B (including cursor data) is dispersed about the mean.

$$\text{Variance} = (\Sigma y^2 - ((\Sigma y)^2 / n)) / n$$

Where y = sample value (average of maximum and minimum), n = number of points between cursors.

- **Standard Deviation** displays the square root of the variance. This measurement is available only when both cursors are displayed.
- **Area** displays the area under the curve. This measurement is available only when both cursors are displayed.

$$\text{Area} = \Sigma xy$$

Where x = time delta for a sample and y = sample value (average of maximum and minimum)

- 4 If necessary, move one or both of the cursors. Cursors must be activated before they can be moved. In the following illustration, cursor A is active and cursor B is inactive.



Activate the cursors you want to move by choosing Cursors >> Active >> A or B. You can also choose the cursor labels to quickly activate/deactivate the cursors.

Move the active cursor or cursors by touching and dragging the bottom of the waveform display area. Ensure you do not touch a cursor label, as the cursor's active status will be changed. Instead, touch an area to the side of the cursor labels.

As cursors are moved, the values in the Channel Information window will update based on the signal values at the new cursor locations.

Note: *In Realtime mode, cursors cannot be moved outside of the viewing window.*

- 5 To modify the cursor color, choose Cursors >> Color. The Color window will open. Select a color and choose OK.

Channel meters

Channel meters provide a variety of ways to visually indicate channel activity.

Channel meter types

Numeric

The numeric meter displays the channel value.



Horizontal Bar

The horizontal bar meter visually represents channel activity in a bar format.

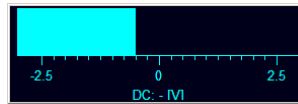

Horizontal Needle

The horizontal needle meter visually represents channel activity with a moving needle.

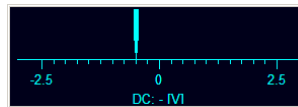

Horizontal LED

The horizontal LED meter visually represents channel activity with LED style bars.

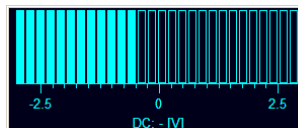

Vertical Bar

The vertical bar meter visually represents channel activity in a bar format.



Vertical Needle

The vertical needle meter visually represents channel activity with a moving needle.



Vertical LED

The vertical LED meter visually represents channel activity with LED style bars.

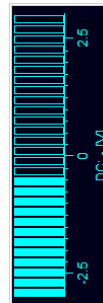

Gauge

The gauge meter visually represents channel activity with a rotating needle.

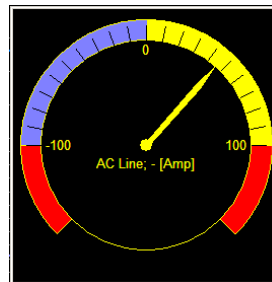

Adding channel meters

1 Choose Analysis >> Meter. The Meter Properties window will open.

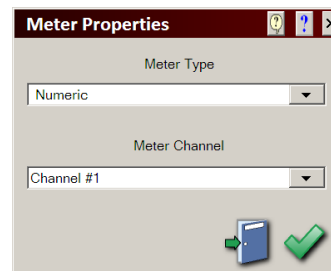

- 2 Select a meter type and the channel that will be displayed in the meter. Choose OK. The meter will be added to the display.

Editing channel meters

- 1 Choose the channel meter you want to edit. A sub menu will appear.
 - To change the meter type or channel, choose Properties. The Meter Properties window will open. Edit the meter options and choose OK.
 - To change the measurement point in Scope and Review modes, choose Screen Left, Cursor A, or Cursor B. The cursor options are available only if cursors are displayed.

Moving channel meters

- 1 Choose the channel meter you want to move. A sub menu will appear. Choose Move.
- 2 Touch the meter and drag it to the new location. Release the meter to lock it into position.

Resizing channel meters

- 1 Choose the channel meter you want to resize. A sub menu will appear.

Note: Numeric meters cannot be resized.
- 2 Resize the meter using one of the following options.
 - **Size Left** - Choose this option to resize by moving the left side of the meter. Touch within the meter and drag horizontally to move the left side.
 - **Size Right** - Choose this option to resize by moving the right side of the meter. Touch within the meter and drag horizontally to move the right side.
 - **Size Top** - Choose this option to resize by moving the top of the meter. Touch within the meter and drag vertically to move the top.
 - **Size Bottom** - Choose this option to resize by moving the bottom of the meter. Touch within the meter and drag vertically to move the bottom.

Removing channel meters

- 1 Choose the channel meter you want to remove. A sub menu will appear.
- 2 Choose Close.

XY plots

XY plots are available for viewing one X channel and up to two Y channels.

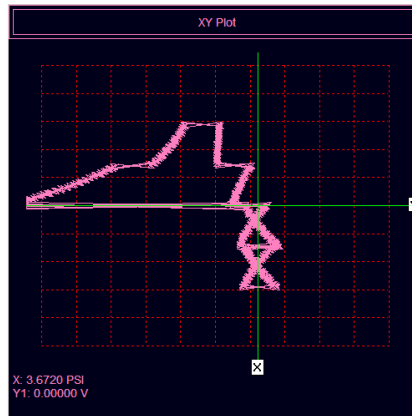

Note: The Review mode plot is generated based upon points in the DCR file being reviewed. When cursors are enabled, however, the plot will be generated based upon review mode screen points.

Adding XY plots

- 1 Choose Analysis >> XY Plot. The XY Properties window will open.

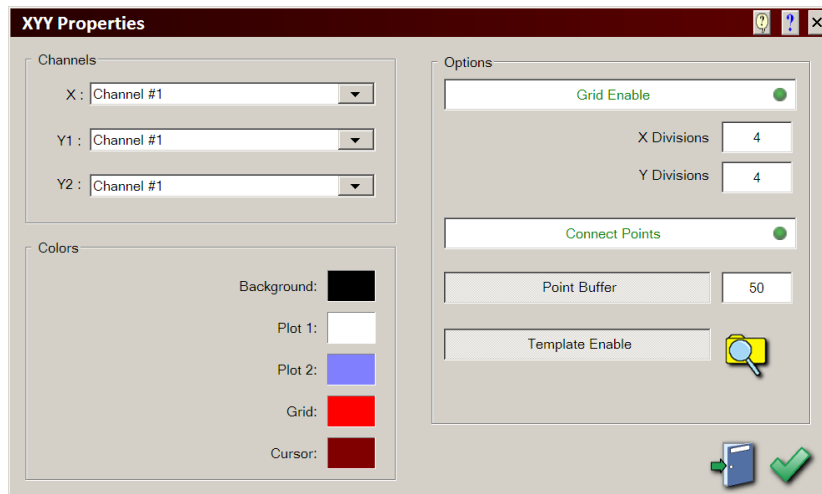

- 2 Use the X, Y1, and Y2 options to select channels to display in the XY plot.

- 3** Select a color scheme for the XYY plot.
 - To specify a background color, choose the Background color box. The Color window will open. Select a color and choose OK.
 - To specify a color for plot 1, choose the Plot 1 color box. The Color window will open. Select a color and choose OK.
 - To specify a color for plot 2, choose the Plot 2 color box. The Color window will open. Select a color and choose OK.
 - To specify a color for the grid, choose the Grid color box. The Color window will open. Select a color and choose OK.
 - To specify a color for cursors, choose the Cursor color box. The Color window will open. Select a color and choose OK.
- 4** To enable a grid in the XYY plot, choose the Grid Enable option. Grid X and Y division fields will appear. Enter the number of divisions to display in the grid.
- 5** To connect the sample points drawn on the plot with line segments, choose the Connect Points option.
- 6** To enable the point buffer, which simulates persistence, choose the point buffer option. A point buffer size field will appear. Enter a point buffer size to indicate how many data points should be used to make the plot.
- 7** Choose OK. The XYY plot will be displayed.
- 8** If necessary, you can clear the plot by choosing the top area of the XYY plot. A sub menu will appear. Choose Clear.
- 9** If necessary, you can print the plot by choosing the top area of the XYY plot. A sub menu will appear. Choose Print.

Editing XYY plots

- 1** Choose the top area of the XYY plot. A sub menu will appear.
- 2** Choose Properties. The XYY Properties window will open.
- 3** Edit the XYY plot options and choose OK.

Moving XYY plots

- 1** Choose the top area of the XYY plot. A sub menu will appear. Choose Move.
- 2** Touch the XYY plot and drag it to the new location. Release the XYY plot to lock it into position.

Resizing XYY plots

- 1** Choose the top area of the XYY plot. A sub menu will appear.

- 2 Resize the XYY plot using one of the following options.
 - **Size Left** - Choose this option to resize by moving the left side of the plot. Touch within the plot and drag horizontally to move the left side.
 - **Size Right** - Choose this option to resize by moving the right side of the plot. Touch within the plot and drag horizontally to move the right side.
 - **Size Top** - Choose this option to resize by moving the top of the plot. Touch within the plot and drag vertically to move the top.
 - **Size Bottom** - Choose this option to resize by moving the bottom of the plot. Touch within the plot and drag vertically to move the bottom.

Using XYY plot cursors

- 1 Choose the top area of the XYY plot. A sub menu will appear.
- 2 Choose Cursor X or Cursor Y to toggle the cursor display.

Cursor measurements will be displayed in the bottom of the XYY plot.

Note: *In Review mode, the cursor information shown at the bottom of the review screen and the Channel Information window will reflect the cursor measurements in either the XYY Plot, Zoom, or Fourier Transform window that is active and selected. If you have cursors on the review screen and the XYY Plot, Zoom, or Fourier Transform windows, you can toggle between measurements by touching the review screen and the appropriate analysis window.*

- 3 To move cursors, choose the top area of the XYY plot. Then choose Move Cursor X or Move Cursor Y. The cursor color will change.

Touch and drag in the XYY plot to move the cursor to a new position, and then release it. To lock the cursor into position, choose the top area of the XYY plot or wait five seconds.

Removing XYY plots

- 1 Choose the top area of the XYY plot. A sub menu will appear.
- 2 Choose Close.

XYY plot templates

XYY plot templates allow you to display a customized background template in the XYY plot window. This background is a visual aid you can use for comparing plot results against a standard template you define.

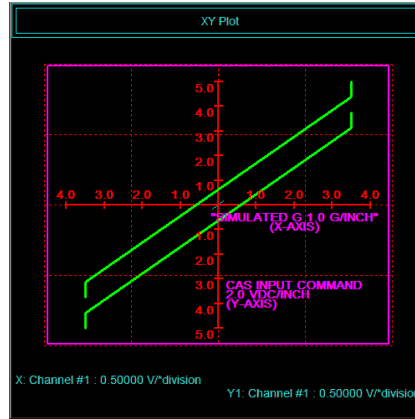

Creating XYY plot templates

An XYY plot template file (*.xyt) specifies text strings and a series of curves created by connecting points. Each curve or text string is positioned based on a coordinate system. The template file creates an image to overlay on an XYY plot.

- 1 Use a plain text editor, such as Notepad, on a personal computer to create and save a template file. Save the file with the extension XYT. This file must be saved with Unicode encoding.
- 2 Define the scaling used in the file by specifying the minimum and maximum values for both the X axis and Y axis. Values range from -32767 to +32767. Refer to the following example:

```
[Scale]
Min=-32767
Max=32767
```

- 3 Define the color that will be used as the transparent color. Choose a color that is unique to all colors used for curves or text. The color is specified in RGB format with values ranging from 0 to 255. Refer to the following example:

```
[Transparent]
Color=55,55,55
```

- 4 Enter curve information in the template file. You can enter up to ten curves. Refer to the following example:

```
[Curve 1]
Thickness=2
Color=255,0,0
Pt1=-26214,-655
Pt2=-26214,655
```

Pt3=-26214,0

- **[Curve Number]** - Enter the curve number between brackets. Curve numbers are specified in the following format: [Curve 1], [Curve 2], [Curve 3], etc. up to [Curve 10].
- **Thickness** - Enter a thickness value for the curve. Curve thickness is specified in pixels and ranges from 1 to 50.
- **Color** - Enter a color for the curve. The color is specified in RGB format with values ranging from 0 to 255.
- **Points** - Enter a list of points to describe the curve. Up to 300 individual points can be specified. Points are specified in the following format: Ptn=x,y

Values for n range from 1 to 300. Values for x and y range from -32767 to +32767.

The points are to be scaled from -32767 to +32767 and are contained in the first quadrant (both X and Y positive).

- 5 Enter text fields in the template file. You can enter up to 100 text fields. Refer to the following example:

```
[Text 1]
Color=255,0,0
Horizontal=0
Vertical=-1
Pt=-26214,786
String=4.0
```

- **[Text Number]** - Enter the text field number between brackets. Text field numbers are specified in the following format: [Text 1], [Text 2], [Text 3], etc. up to [Text 100].
- **Color** - Enter a color for the text. The color is specified in RGB format with values ranging from 0 to 255.
- **Horizontal** - Specify the horizontal alignment of the text: (-1) left justified, (0) centered, (1) right justified.
- **Vertical** - Specify the vertical alignment of the text: (-1) bottom, (0) centered, (1) top.
- **Pt** - Enter the point at which to position the text field. Points are specified in the following format: Pt=x,y

Values for x and y range from -32767 to +32767. Alignment is based on this point.

- **String** - Enter the text string to display in the field. You can enter up to 100 characters.

- 6 Save the template file. Ensure you save it with a XYT extension. Then copy it to a USB-based memory storage device.

Loading XYY plot templates

- 1 Insert the USB-based memory storage device that contains the template (*.xyt) file into the recorder USB port.

Note: If you plan to use the template file often, you may want to copy it to the *C:\tmx\XY Templates* folder using the Operating System utility.

- 2 Choose whether to add an XYY plot template to a new XYY plot or an existing one.
 - To use an XYY plot template on a new plot, choose Analysis >> XYY Plot. The XYY Properties window will open.
 - To use an XYY plot template on an existing plot, choose the top area of the XYY plot. A sub menu will appear. Choose Properties. The XYY Properties window will open.

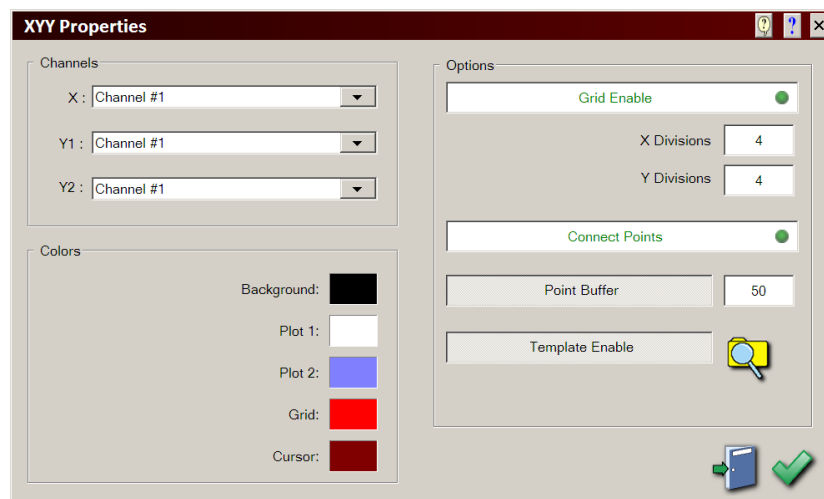

- 3 Configure any other XYY template options if needed.
- 4 Choose the Template Enable option. Then choose the Browse Folders icon and select an XYY template to load. By default, files in the default location on the system drive (C) will be displayed. If necessary, you can select a file from a different location by choosing the folder list and browsing to a folder. Choose OK.
- 5 Choose OK in the XYY Properties window. The XYY plot will be displayed with the selected template.

Adjusting XYY plot templates

- 1 Choose the top area of the XYY plot. A sub menu will appear.
- 2 To move the template, choose Shift Template.

Touch and drag in the XYY plot to move the template to a new position, and then release it. To lock the template into position, choose the top area of the XYY plot or wait five seconds.

- 3 To rotate the template, choose Rotate Template.

Touch and drag in the XYY plot to rotate the template, and then release it. To lock the template into position, choose the top area of the XYY plot or wait five seconds.

Fourier Transform window

The Fourier Transform is created from the data displayed in the waveform display area. This data can consist of up to 1024 segments. Each segment consists of two points, a minimum and maximum, which represent the minimum and maximum signal values for each period.

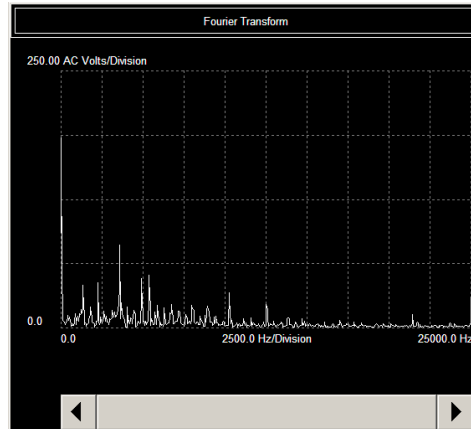

Fourier Transform calculations require a single point for each period. The point used for the Fourier Transform calculation is the midpoint of the minimum and maximum. Therefore, a signal overlay compressed may not yield accurate Fourier Transform results.

Adding Fourier Transform windows

- 1 Choose Analysis >> Fourier Transform. The Fourier Transform Properties window will open.

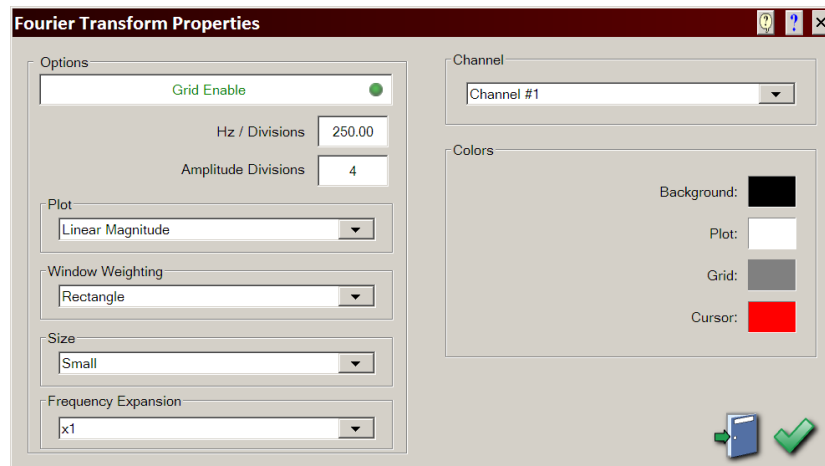

- 2 Select the channel to display in the Fourier Transform window.
- 3 To display a grid, choose the Grid Enable option. Then specify Hz/divisions and amplitude divisions values.
- 4 Use the plot option to choose between linear magnitude, logarithmic magnitude, or magnitude².

- 5 Choose a window weight option. The following options are available: Hanning, Hamming, Blackman, Barlett, Triangle, Kaiser, Bman-Harris, and Rectangle.
- 6 Select whether to display a small, medium, or large size Fourier Transform window.
- 7 If necessary, use the Frequency Expansion option to expand the frequency axis and provide a more detailed view.
- 8 Select a color scheme for the Fourier Transform window.
 - To specify a background color, choose the Background color box. The Color window will open. Select a color and choose OK.
 - To specify a plot color, choose the Plot color box. The Color window will open. Select a color and choose OK.
 - To specify a color for the grid, choose the Grid color box. The Color window will open. Select a color and choose OK.
 - To specify a color for cursors, choose the Cursor color box. The Color window will open. Select a color and choose OK.
- 9 Choose OK. The Fourier Transform window will be displayed.
- 10 If necessary, you can print the Fourier Transform by choosing the top area of the Fourier Transform window. A sub menu will appear. Choose Print.

Editing Fourier Transform windows

- 1 Choose the top area of the Fourier Transform window. A sub menu will appear.
- 2 Choose Properties. The Fourier Transform Properties window will open.
- 3 Edit the Fourier Transform window options and choose OK.

Moving Fourier Transform windows

- 1 Choose the top area of the Fourier Transform window. A sub menu will appear.
- 2 Touch the Fourier Transform window and drag it to the new location. Release the window to lock it into position.

Resizing Fourier Transform windows

- 1 Choose the top area of the Fourier Transform window. A sub menu will appear.
- 2 Choose Small Size, Medium Size, or Large Size to resize the window

Using Fourier Transform window cursors

- 1 Choose the top area of the Fourier Transform window. A sub menu will appear.
- 2 Choose Cursor A or Cursor B to toggle the cursor display.

Cursor measurements will be displayed in the bottom of the Fourier Transform window.

Note: *In Review mode, the cursor information shown at the bottom of the review screen and the Channel Information window will reflect the cursor measurements in either the*

XY Plot, Zoom, or Fourier Transform window that is active and selected. If you have cursors on the review screen and the XY Plot, Zoom, or Fourier Transform windows, you can toggle between measurements by touching the review screen and the appropriate analysis window.

- 3** To move cursors, choose the top area of the Fourier Transform window. Then choose Move Cursor A or Move Cursor B. The cursor color will change.

Touch and drag in the Fourier Transform window to move the cursor to a new position, and then release it. To lock the cursor into position, choose the top area of the Fourier Transform window or wait five seconds.

Removing Fourier Transform windows

- 1** Choose the top area of the Fourier Transform window. A sub menu will appear.
- 2** Choose Close.

Zoom window

The Zoom window magnifies a portion of a capture for detailed analysis. Data displayed in the Zoom window is generated based upon points in the DCR file being reviewed.

Adding Zoom windows

- 1** Choose Analysis >> Zoom. The Select Zoom Area window will open.



- 2** Create the zoom area by pressing anywhere on the waveform display area. While pressing, drag diagonally away from the first point to create a rectangular area.

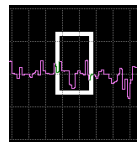

- 3 Choose OK in the Select Zoom Area window. The Zoom window will open.

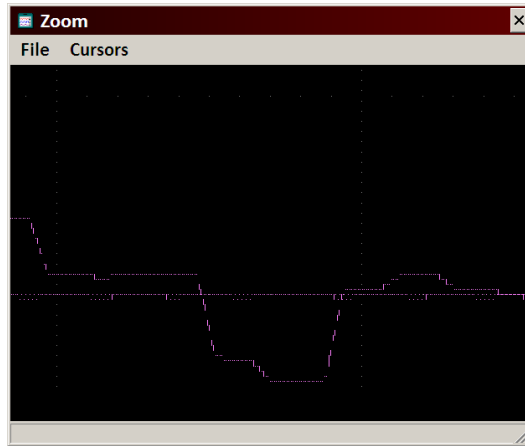

The Zoom window displays the rectangular area selected. Cursors are available via the Cursors menu.

Note: *In Review mode, the cursor information shown at the bottom of the review screen and the Channel Information window will reflect the cursor measurements in either the XYY Plot, Zoom, or Fourier Transform window that is active and selected. If you have cursors on the review screen and the XYY Plot, Zoom, or Fourier Transform windows, you can toggle between measurements by touching the review screen and the appropriate analysis window.*

- 4 If necessary, you can scroll the zoom area by pressing and dragging the outlined area in the waveform display.
- 5 If necessary, you can print the zoom area by choosing File >> Print in the Zoom window.

13

Networking and communications

IP information

The recorder can be connected to a network and assigned an IP address for TCP/IP communication. The factory default IP settings are indicated below.

- IP Address: 192.168.255.1
- Subnet Mask: 255.255.255.0
- Gateway: None

Modifying IP information

The recorder can be assigned a specific IP address or it can obtain one automatically using Dynamic Host Configuration Protocol (DHCP).

- 1 Choose Configuration >> Utilities from the menu bar to open the utilities screen.

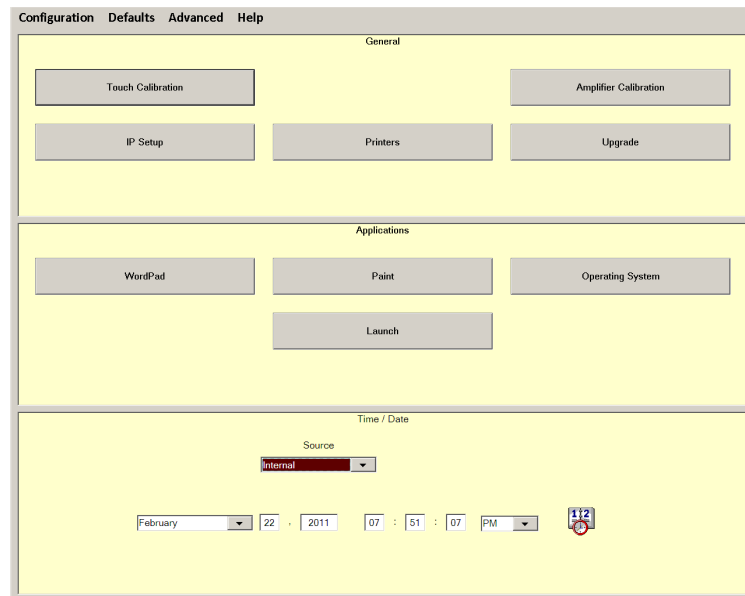

- 2 Choose the IP Setup button. The IP Setup window will open.

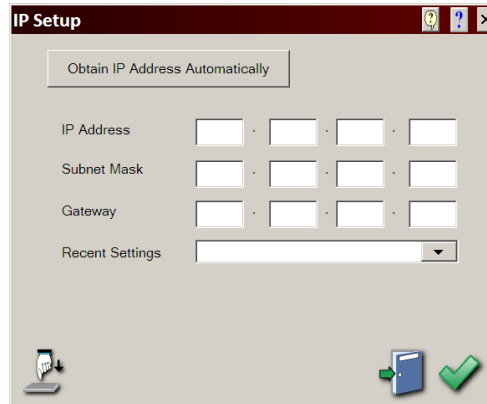

- 3 To use DHCP, choose the Obtain IP address automatically button.
- 4 To specify specific values for the IP address, enter values for the IP address, subnet mask, and gateway. Enter an address by choosing a field and entering a value using the number pad. Repeat this process until the entire address is specified.

When an IP address is used, it will be added to the Recent Settings drop-down list. To select this address in the future, select it from the list instead of entering it again.
- 5 Choose OK.

Copying files from the system drive to a USB or network drive

You can copy setup, data capture, and scope capture files from the system drive to a USB or network drive. If you are using a USB drive, ensure you have inserted a USB drive into a USB port. If you are using a network drive, ensure the recorder is connected to the network.

Note: *Data captures and scope captures must be archived before you can copy them from the system drive.*

- 1 Open the Select File window for the type of file you want to copy.
 - To copy a global setup file, choose File >> Load >> Global.
 - To copy a signal setup file, choose File >> Load >> Signals.
 - To copy a view setup file, choose File >> Load >> View.
 - To copy a control panel setup file, choose File >> Load >> Control Panel.
 - To copy a capture setup file, choose File >> Load >> Capture.
 - To copy a trigger setup file, choose File >> Load >> Trigger.
 - To copy an archived data capture, choose Configuration >> Review to open the Review mode file selection window. Choose the Archived Data Capture icon.



- To copy an archived scope capture, choose Configuration >> Review to open the Review mode file selection window. Choose the Archived Scope Capture icon.



- 2 Select the file or files you want to copy. You can select multiple files by touching and dragging in the selection area.

Note: *When selecting an archived data capture, select the folder associated with the data capture. Do not select individual files within that folder.*

- 3 Choose the Copy icon.



- 4 In the Select File window, browse to the desired USB drive or network location. Then choose the Paste icon.



The selected items will be pasted to the chosen location.

File transfer protocol (FTP)

This section provides information on using FTP applications to transfer files to and from the TMX. It also provides a detailed list of the TMX folder structure and file types.

Using FTP applications

Any FTP program can be used to log into the TMX and transfer files. Some web browsers also provide FTP functionality. When using a browser, enter the FTP address in the address bar.

Note: *FTP applications will provide access to all files on the TMX, including important system files. Use caution to ensure that system files are not accidentally deleted.*

- 1 Ensure the recorder is on and properly connected to a network.
- 2 On the TMX, choose Configuration >> Utilities to open the Utilities screen. Then choose Advanced >> Enable FTP Server.

A check mark will be displayed next to the Enable FTP Server menu to indicate the FTP function is active.
- 3 Launch a file transfer protocol (FTP) application using a computer connected to the same network.
- 4 Log into the TMX using the following information:
 - **FTP Address:** ftp://192.168.255.1 (or other IP address if changed)
 - **User Name:** Leave this field blank (Anonymous)
 - **Password:** Leave this field blank

TMX folders and files

All TMX files are stored in a folder located in the root directory (C:\TMX). The following table describes the folders within the TMX folder.

Folder	Description
ASCII Capture Files	This folder contains all data capture files that have been saved in ASCII format. These files have a CSV extension.
Capture Setup Files	This folder contains data capture setup files. These files have a DCS extension.
Control Panel Setup Files	This folder contains three folders (Realtime, Review, and Scope). These folders contain control panel setup files for Realtime, Review, and Scope mode. The file extensions for these files are as follows: <ul style="list-style-type: none"> • Realtime control panel file.DCP • Review control panel file.RCP • Scope control panel file.SCP

Folder	Description
Data Capture Files	<p>This folder contains sub folders that represent data capture files. To transfer data capture files, copy the entire folder. The data capture folders contain a data capture record (DCR) file, and an IDX file, which contains a listing of external items used in a data capture (notes, scope captures, etc.). Additionally, these external items are also stored in this folder.</p> <p>Data capture record (DCR) files can be opened and analyzed with AstroVIEW X or TMX offline software.</p>
Global Setup Files	<p>This folder contains global setup files. These files have a DGS extension.</p>
Scope Capture Files	<p>This folder contains scope capture record files. These files have a SCR extension.</p>
Signal Setup Files	<p>This folder contains signal setup files. These files have an extension of DSS.</p>
System Capture Files	<p>This folder contains files for system use only.</p>
Trigger Setup Files	<p>This folder contains trigger setup files. These files have a DTS extension.</p>
Upgrade	<p>This folder is used to upgrade the TMX software. It is also used to automatically load setup files. When a setup file is transferred to this folder, the file will automatically be loaded, and then deleted from the folder.</p>
Upload	<p>This folder is used to automatically load global setup files</p>
View Setup Files	<p>This folder contains view setup files in two sub folders; Realtime and Scope. These files have an extension of DVS and SVS, respectively</p>
XY Templates	<p>This folder contains XYY plot template files. These files have an XYT extension.</p>

14

Utilities and service options

Utilities screen

Choose Configuration >> Utilities from the menu bar to open the utilities screen.

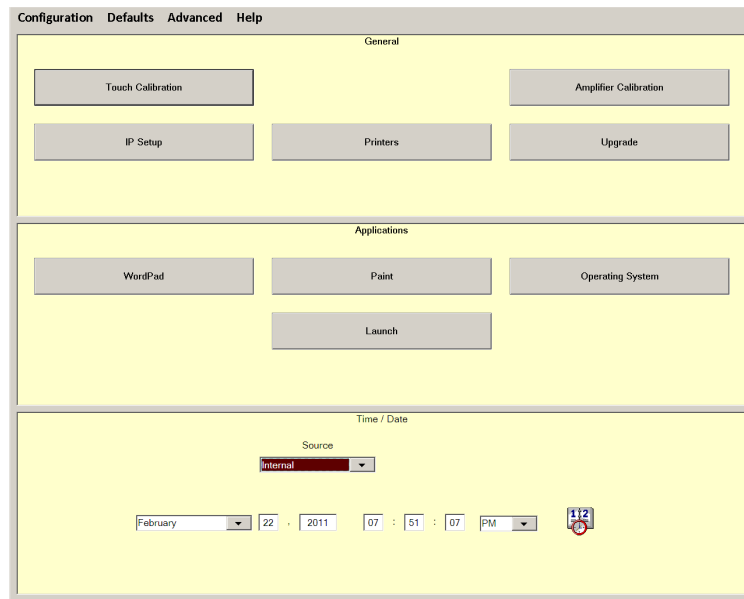

Utilities and other options are available from this screen.

Restoring default settings

In some situations, it may be helpful to restore settings to the factory-default state.

- 1 Choose Configuration >> Utilities from the menu bar to open the utilities screen.

- 2 Choose Defaults. A sub menu will appear. Choose a default option.
 - **Channel Settings** - This option restores default settings for channel amplifier inputs, base channels, derived channels, and event inputs.
 - **Realtime View** - This option restores the default view settings for Realtime mode.
 - **Realtime Panel** - This option restores the default control panel for Realtime mode.
 - **Scope View** - This option restores the default view settings for Scope mode.
 - **Scope Panel** - This option restores the default control panel for Scope mode.
 - **Review Panel** - This option restores the default control panel for Review mode.
 - **Trigger Settings** - This option restores the default trigger settings.
 - **Capture Settings** - This option restores the default data capture settings.
 - **System** - This option restores the default settings for all previous options.

A confirmation message will appear.

- 3 To confirm the default settings, choose OK. To cancel the default settings, choose Cancel.

Showing and hiding the cursor

By default, the cursor/pointer is not visible on the display. However, you can show/hide the cursor from the utilities screen. When the cursor is visible, an arrow icon will indicate the current focus on the touch screen. The arrow icon will not be displayed when the cursor is set to hidden.

- 1 Choose Configuration >> Utilities from the menu bar to open the utilities screen.
- 2 Choose Advanced >> Show Cursor to toggle between the visible and hidden cursor.

Selecting a language

- 1 Choose Configuration >> Utilities from the menu bar to open the utilities screen.

- 2 Choose Help >> Language from the menu bar. A sub menu will appear. The following language options are available:
 - American
 - British
 - French
 - Italian
 - German
- 3 Select a language. The selected language will be used for all text in the software.

General utilities

The following general utilities are available in the utilities screen.

Touch Calibration

The Touch Calibration utility is used to set up the touch screen calibration and other display options.

Amplifier Calibration

The Amplifier Calibration utility is used to calibrate input channels.

IP Setup

The IP Setup utility is used to specify IP address information for the recorder in network environments.

Printers

The Printers utility is used to install an external printer.

Upgrade

The Upgrade utility is used to upgrade the system software.

Related Topics:

- *Calibrating the touch screen on page 185*
- *Calibrating channels on page 186*
- *Modifying IP information on page 177*
- *Installing Windows-based printers on page 36*
- *Upgrading the system software on page 186*

Calibrating the touch screen

- 1 Choose Configuration >> Utilities from the menu bar to open the utilities screen.
- 2 Choose the Touch Calibration button. The touch-screen calibration process will start and a touch target will be displayed.

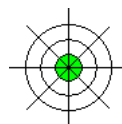

- 3 Touch and hold the center of the target for approximately 2-3 seconds. Then release the target. If a new touch target is displayed, repeat this process.

When the touch-screen calibration process is complete, a confirmation message will appear. Choose the Accept option.

Upgrading the system software

Software upgrades may be released in the future for the recorder. Use the following instructions to upgrade the system software.

- 1 Insert a USB flash memory drive containing the software upgrade.
- 2 Choose Configuration >> Utilities from the menu bar to open the utilities screen.
- 3 Choose Upgrade. The system software will be upgraded and you will be prompted to turn the system off.
- 4 Turn the TMX power off.
- 5 Remove the USB flash memory drive from the TMX. The TMX will not boot up with a USB key inserted into the USB port.
- 6 Turn the TMX power on.

Calibrating channels

The calibration function adjusts the calibration of the signal input channels based on known standards. Calibration should be performed approximately once per year. New recorders are calibrated at the factory.

Note: *Known voltages must be applied during the calibration process. Ensure that all required voltages are available prior to starting the calibration process.*

- 1 Choose Configuration >> Utilities from the menu bar to open the utilities screen.
- 2 Choose the Amplifier Calibration button. The Enter Password window will open. Enter the calibration password and choose OK.

Note: The default calibration password is “astromed” (lowercase, without the quotation marks).

The Analog Calibration window will open.

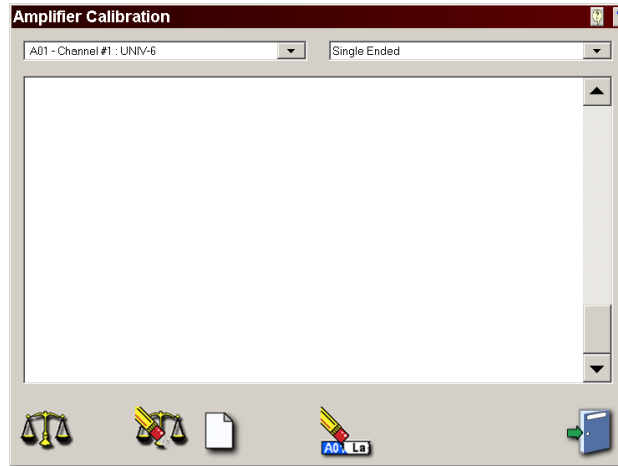

- 3 Select a channel and the input settings for the channel.
- 4 If necessary, you can view the calibration factors for the selected channel by choosing the Show Factors icon.



- 5 If necessary, you can clear the calibration settings for the selected channel by choosing the Clear Factors icon.



Clearing a channel’s calibration settings will set these values to null. After being cleared, these channels will need to be calibrated before they will work properly.

- 6 Choose the Start Calibration icon.



- 7 The system will prompt you to short the inputs of the channel. This enables the baseline calibration for each attenuator to be performed.
- 8 The recorder will prompt for specific voltages to be placed at the selected input channel. These voltages will differ based on the input module being calibrated.

Note: The calibration process for each voltage may require several minutes.

Module	Required Voltages
UNIV-6 (Single Ended)	1V, 10V, 50V, 200V, 250V

Module	Required Voltages
UNIV-6 (Differential)	40mV, 500mV, 1V
NIDV-16	200mV, 400mV, 800mV, 2V, 4V, 5V, 10V, 25V, 50V
IHVM-6	0V, 40V, 200V, 325V
ITCU-12	0V, 50mV, -100 degrees C

- 9 When all attenuators have been calibrated, calibrate another channel if necessary.
- 10 If necessary, you can cancel calibration by choosing the Abort Calibration icon.



Pressing this icon will stop the calibration process, however, the process must be completed from start to finish to ensure that the channel's attenuators will work properly.

- 11 When finished, choose the X icon to close the Calibration window.

Related Topics:

- *Changing passwords on page 190*

Viewing factory calibration data

When the recorder is calibrated at the factory, calibration verification reports are generated and placed in a folder on the Windows desktop. You can open these reports and view them on the recorder using Adobe Acrobat Reader.

- 1 Choose Configuration >> Utilities from the menu bar to open the utilities screen.

From the Utilities screen, choose the Operating System button. The Enter Password window will open.

Enter the system password and choose OK. The TMX software will shut down, providing access to the operating system.

Note: *The default system password is "tmx" (lowercase, without the quotation marks).*

- 2 Open the TMX Test Cell Data folder on the Windows desktop.

This folder contains a calibration data report in PDF format for each input module installed in the recorder. It includes information from the last time the calibration was verified at the factory. Reports are named based on the input module serial number.

- 3 Open a report.

Application utilities

The following application utilities are available in the utilities screen.

WordPad

The WordPad utility is used to launch Microsoft® WordPad. This application is a text editor that can be used to create and save basic documents. A keyboard must be used to allow typing while in WordPad.

To launch WordPad, choose the WordPad button. When WordPad is open, all other utility options will become unavailable.

Paint

The Paint utility is used to launch Microsoft® Paint. This application is a graphics editor that can be used to create and save basic graphic and screen captures.

To launch Paint, choose the Paint button. When Paint is open, all other utility options will become unavailable.

Launch

The Launch utility is used to launch other applications while the TMX software is running.

Operating System

The Operating System utility is used to exit the TMX software and access the Windows operating system.

Related Topics:

- *Using the Launch utility on page 189*
- *Using the Operating System utility on page 190*

Using the Launch utility

The Launch utility is used to launch other applications while the TMX software is running.

Note: *Astro-Med, Inc. does not guarantee that any application can be used while running the TMX.*

- 1 Choose Configuration >> Utilities from the menu bar to open the utilities screen.
- 2 Choose the Launch button. The Launch Application window will open.

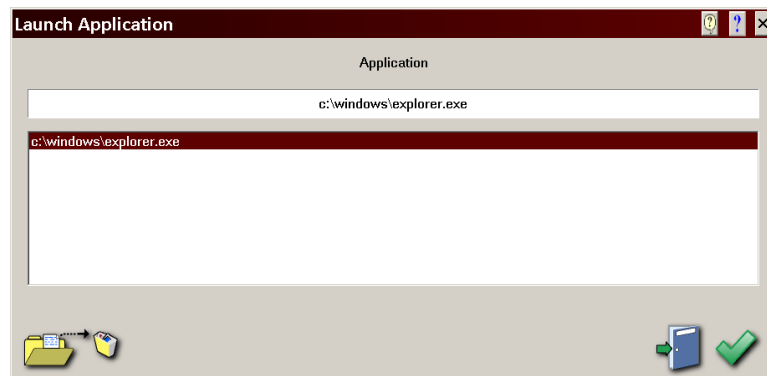

- 3 Choose the Application field. Then enter the full path of a program's ".exe" file using the keypad and choose the OK button. Choose OK in the Launch Application window. The program will be launched.

When a program is successfully launched, the path will be added to the list in this window. To launch the program in the future, select it from the list and choose OK instead of entering the path again.

Paths can be removed from this list by selecting the path and choosing the delete button.

Using the Operating System utility

The Operating System utility is used to exit the TMX software and access the Windows operating system.

Note: You will need to use this procedure to access any applications that aren't listed on the Utilities screen.

- 1 Choose Configuration >> Utilities from the menu bar to open the utilities screen.
- 2 Choose the Operating System button. The Enter Password window will open.
- 3 Enter the system password and choose OK. The TMX software will shut down, providing access to the operating system.

Note: The default system password is "tmx" (lowercase, without the quotation marks).

Related Topics:

- Changing passwords on page 190

Setting the system time

Note: These instructions assume you are not using the TMX-IRIG/GPS option.

- 1 Choose Configuration >> Utilities from the menu bar to open the utilities screen.
- 2 Use the time fields and drop-down lists to enter the current date and time.

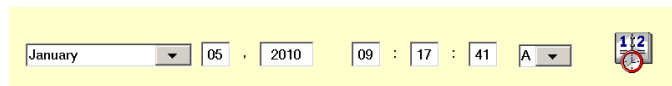

Related Topics:

- TMX-IRIG/GPS on page 42

Changing passwords

This section describes how to change the system and calibration passwords.

Changing the system password

The system password is a security tool that prevents unauthorized access to the menu bar, operating system, and other functions.

- 1 From Realtime, Scope, or Review mode, choose Security >> Set Password. The Enter Current Password window will open.
- 2 Enter the current system password and choose OK. The Enter New Password window will open.

Note: The default system password is “tmx” (lowercase, without the quotation marks).

- 3 Enter the new system password and choose OK. The Verify New Password window will open.
- 4 Re-enter the new system password and choose OK.

Changing the calibration password

You are required to enter a password in order to access the Analog Calibration window. By default, this password is the same as the system password. However, you can assign a unique password to the Analog Calibration window.

- 1 Choose Configuration >> Utilities from the menu bar to open the utilities screen.
- 2 Choose Advanced >> Set Calibration Password. The Enter Current Password window will open.
- 3 Enter the current calibration password and choose OK. The Enter New Password window will open.

Note: The default calibration password is “astromed” (lowercase, without the quotation marks).

- 4 Enter the new calibration password and choose OK. The Verify New Password window will open.
- 5 Re-enter the new calibration password and choose OK.

Viewing and modifying utility / DIO port settings

- 1 From Realtime, Scope, or Review mode, choose Service >> Utility Port. The Utility Port Settings window will open.

This window provides a graphical representation of the utility port pins and setup options.

- 2 Specify a chart/page mark input option.
 - **Chart Mark** - The Chart Mark option prints a mark on the printed chart.
 - **Page Mark** - The Page Mark option prints a full-page mark on the scrolling waveform display area.
- 3 To modify alarm output settings, select a channel (or multiple channels with “or” logic). When an alarm condition is met for the selected channels, the alarm output will occur.

- 4 Specify the print input option.
 - **Print Demand** - The Print Demand option will print the demand buffer.
 - **Print ID** - The Print ID option will print the channel IDs.
 - **Print Channel Labels** - The Print Channel Labels option will print the labels assigned to each channel.
- 5 Choose OK.

Using the calculator

Use the following instructions to access the calculator program, which is part of the Windows operating system.

- 1 From Realtime, Scope, or Review mode, choose Service >> Calculator to open the Calculator window.

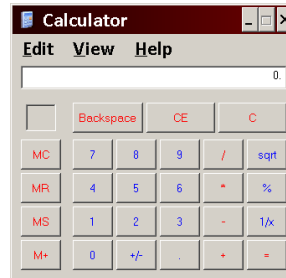

- 2 Choose the X button to close the Calculator window.

Selecting a video standard

If the TMX-VA option is enabled, and you are using an external video camera, you can select the video standard that will be used.

Note: For information about adding the TMX-VA option to your system, please contact Test & Measurement Sales.

- 1 Choose Configuration >> Utilities from the menu bar to open the utilities screen.
If the TMX-VA option is enabled, the Video Settings button will be available.
- 2 Choose Video Settings. The Video Settings window will open.

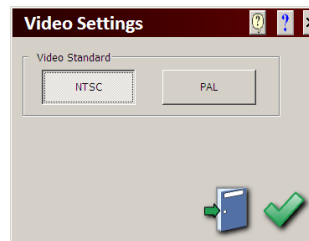

- 3 Choose whether to use the NTSC or PAL video standard.

4 Choose OK.

Related Topics:

- *Viewing real-time video on page 94*
- *Setting up a video capture on page 103*

TMX offline overview

TMX offline software is the TMX program modified to run on a personal computer running Windows XP, Windows Vista, or Windows 7. It provides most of the functionality of the standard TMX program and can be used for a variety of purposes.

Some common uses of the offline software include:

- **Setup file creation** - The offline software can be used to create global, signal, view, control panel, capture, and trigger setup files. Once created, these files can be transferred to a TMX using a USB storage device or network connection.
- **Data review** - The offline software can be used to view data files captured using the TMX. Data files can be reviewed with TMX offline Review mode.

Note: *The required minimum display resolution is 1280 x 1024.*

Note: *Do not confuse TMX offline software with AstroVIEW X. TMX offline is an optional program that emulates the TMX environment on a personal computer. AstroVIEW X is a program that provides the capability to review data capture files on a personal computer. These are two distinct software products.*

TMX offline installation

A wizard-based installation is used to install the TMX offline software. The installation program should automatically run when the CD is inserted in a CD drive.

If the program does not automatically run, launch the “setup.exe” file from the CD using Windows Explorer or the Run option from the Start menu (d:/setup.exe - where d: is the CD drive).

Note: *If National Instruments LabVIEW Run-Time Engine software is not installed, the installation wizard will guide you through this process.*

After the installation process, start the TMX offline software by using the TMX Offline icon on the desktop. Exit the program by choosing File >> Exit.

Note: *When you start the TMX offline software, a Windows security alert message may appear. Choose to unblock the program if prompted.*

File transfer

Transferring data files from the TMX to a computer running TMX offline software can be accomplished with a USB storage device or file transfer protocol (FTP) via a network connection.

Related Topics:

- *Copying files from the system drive to a USB or network drive on page 178*
- *File transfer protocol (FTP) on page 179*

Selecting offline input modules

When using the offline software to create setup files, you will need to set up virtual input modules to match those installed in the recorder.

- 1** In the offline software, choose Configuration >> Utilities to open the offline utilities screen.
- 2** Choose the Module Configuration button. The Module Configuration window will open.

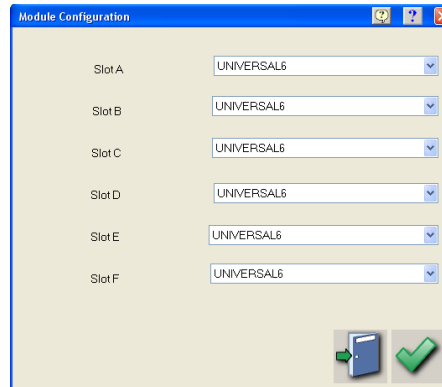

- 3** Select the input modules that are installed in the corresponding slots on your TMX. If a blank module is installed in a slot, choose MODULE_NOT_PRESENT for the slot.
- 4** Choose OK.

A

Specifications

Color display

Type	Active matrix color LCD (TFT)
Viewing Area	17.0 inch (diagonal)
Resolution	1280 x 1024
Touch	Full screen, resistive

Signal modules

Maximum Modules	6 (3 in main chassis, 3 in external chassis)
Maximum Waveforms	96 (48 in main chassis, 48 in external chassis)
Event inputs	16
Engineering Units	User defined units with $y=mx+b$ scaling
Pre-capture Filter	Lowpass, highpass, bandpass, bandstop, RMS
Post-capture Filter	Lowpass, highpass, bandpass, bandstop, RMS
Calibration	Semi-automated to external reference

Utility / DIO port

See "Utility / DIO port pin configuration" on page 12.

UNIV-6 module

Channels Per Module	6
Rated Isolation	250 VRMS or DC, Cat II (iso-common to chassis and other iso-commons)

Sample Rate	800 KHz (400 KHz when using TMX-E or TMX-R)
A/D	16 bit SAR (one per channel)
Anti-Aliasing Filter	4 pole Bessel
Counter Capability	Yes, first channel. Software selectable.
Counter Modes	Gated time frequency counter, cycle based frequency counter, pulse counter, pulse width detector, period width detector, duty cycle detector
Frequency ctr range (menu)	Up to 120 KHz
Frequency ctr range (spec)	2 - 100 KHz (48 Hz - 100 KHz for cycle based frequency counter)
Frequency ctr accuracy	+/- 0.07% of Measurement +.002 Hz
Min counter input amplitude	25% of span for freq and pulse counters, 90% of span for all other modes
Pulse counter range	64000000 maximum. (16 bit display resolution)
Pulse width accuracy	0.7 μ s +.00167% of span
Pulse width range	10 μ s - 40000 μ s
Period width accuracy	.02% of measurement +.00167% of span with a maximum of 1.00 μ s
Period width range	5 μ s - 90000 μ s (11 Hz - 200 KHz)
Duty cycle accuracy	.5% (Inputs in the 15 Hz - 10 KHz range with 20% - 80% duty cycles)
Cold Start Drift	< 0.1% of attenuator (60 min.)
Single Ended Input	
Connector	Guarded banana jacks (red/black)
Input	Single-ended, AC/DC coupled
Bandwidth	100 KHz (-3dB) (400V, 200V and 50V attenuators) 90 KHz (-3dB) (10V and 1V attenuators)
AC Coupled 3dB Point	< 0.54 Hz
Off Ground Measurements	Yes

Zero Suppression	Yes
Attenuator Ranges	1, 10, 50, 200 and 400 Volt
Measurement Ranges	+/- 400 V (400 VFS or 800 VFS w/ zero offset) +/- 200 V (200 VFS or 400 VFS w/ zero offset) +/- 50 V (50 VFS or 100 VFS w/ zero offset) +/- 10 V (10 VFS or 20 VFS w/ zero offset) +/- 1 V (1 VFS or 2 VFS w/ zero offset. 0.2V min span)
Max Rated Input	250 Vrms or DC, Cat II
Max Transient Input	+/- 800 V peak (not to exceed 250Vrms)
DC Accuracy (25°C)	+/- 0.07% of attenuator
Overshoot	< 1.0%
Intrinsic Noise (pk-pk)	< 0.08% of attenuator + .08% of span (400V through 10V atts) < 0.17% of attenuator + .07% of span (1V att)
IMR at 60 Hz	Better than -75 dB
Min Input Impedance	> 1 Megohm
Differential Input	
Connector	4 wire screw terminal
Input	Differential, DC coupled
Bandwidth	50 KHz
Measurement Ranges	+/- 1000 mV +/- 500 mV +/- 50 mV
Max Transient Input	+/- 20 V (no damage)
Common Mode Voltage	+/- 3V
Zero Suppression	Yes
DC Accuracy (25°C)	+/- 0.07% of attenuator
Overshoot	< 1.0%
Intrinsic Noise (pk-pk)	< 0.08% of attenuator + .09% of span (1000 mV & 500 mV atts) < 0.14% of attenuator + .08% of span (50 mV att)

Input Impedance	> 300 K Ω (150 K Ω balanced to isolated common)
CMR at 60 Hz	> 85 dB
Excitation	DC adjustable, 0.1 to 10 V. 30 mA maximum
Excitation Accuracy	0.05 V
Bridge Auto Balance	Yes. Up to 10% of attenuator (limited by maximum span).

NIDV-16 module

Channels Per Module	16
Connectors	Two 25-pin D-sub male connectors
Isolation	No
Sample Rate	200 KHz (100 KHz when using TMX-E or TMX-R)
A/D	16 bit SAR (one per channel)
Anti-Aliasing Filter	4 pole Bessel
Bandwidth	40 KHz (-3dB)
Input	Differential, DC coupled
Off Ground Measurements	Yes
Zero Suppression	Yes, digital
Attenuator Ranges	200, 400 and 800 mV; 2, 4, 5, 10, 25 and 50 V
Measurement Ranges	+/- 200 mV (80 to 160 mVFS or 400 mVFS w/ zero offset) +/- 400 mV (400 mVFS or 800 mVFS w/ zero offset) +/- 800 mV (800 mVFS or 1.6 VFS w/ zero offset) +/- 2 V (1.6 VFS or 4 VFS w/ zero offset) +/- 4 V (4 VFS or 8 VFS w/ zero offset) +/- 5 V (5 VFS or 10 VFS w/ zero offset) +/- 10 V (10 VFS or 20 VFS w/ zero offset) +/- 25 V (20 VFS or 50 VFS w/ zero offset) +/- 50 V (50 VFS or 100 VFS w/ zero offset)

Max Rated Input	35 Vrms or 50 VDC
Max CMV Input	+/- 50 VDC (Either input referenced to ground)
Max Transient Input	+/- 60 V peak (Either input referenced to ground. No damage.)
DC Accuracy (25°C)	+/- 0.07% of attenuator (800 mV, 2, 4, 5, 10, 25 and 50 V attenuators) +/- 0.1% of attenuator (400 mV attenuator) +/- 0.15% of attenuator (200 mV attenuator)
Cold Start Drift	< 0.5% of attenuator (60 min.)
Overshoot	< 1% of attenuator
Intrinsic Noise (pk-pk)	< 0.1% of attenuator + 4 mV
Overshoot	< 1%
Min Input Impedance	> 500 K Ω (250 K Ω balanced to signal common)
CMR at 60 Hz	Better than -60 dB
Excitation	No
Auxiliary Power Output	Yes. 12V @ 200 mA (total of the two connectors)
Counter Capability	Yes. Software selectable on channels 1 and 2
Counter Modes	Gated time frequency counter, cycle based frequency counter, pulse counter, quadrature counter, pulse width detector, period width and duty cycle detector
Frequency ctr range (menu)	2 - 50 KHz
Frequency ctr range (spec)	2 - 40 KHz (48 Hz - 100 KHz for cycle based frequency counter)
Frequency ctr accuracy	+/- 0.05% of Measurement +.002 Hz
Min counter input amplitude	25% of att for freq and pulse counters, 90% of att for all other modes
Pulse counter range	64000000 maximum. (16 bit display resolution)
Pulse width accuracy	1.5 μ s +.00167% of span
Pulse width range	40 μ s - 40000 μ s
Period width accuracy	.02% of measurement +.00167% of span with a maximum of 1.00 μ s

Period width range	5 μ s - 90000 μ s (11 Hz - 50 KHz)
Duty cycle accuracy	.5% (Inputs in the 15 Hz - 10 KHz range with 20% - 80% duty cycles)

IHVM-6 module

Channels Per Module	6
Rated Isolation	600 VAC RMS or 1000 VDC, Cat IV (channel to channel and channel to chassis)
Sample Rate	800 KHz (400 KHz when using TMX-E or TMX-R)
A/D	16 bit SAR (one per channel)
Anti-Aliasing Filter	4 pole Bessel
Counter Capability	Yes, first channel. Software selectable.
Counter Modes	Gated time frequency counter, cycle based frequency counter, pulse counter, pulse width detector, period width detector, duty cycle detector.
Frequency ctr range (menu)	Up to 100 KHz
Frequency ctr range (spec)	2 - 70 KHz (48 Hz - 70 KHz for cycle based frequency counter)
Frequency ctr accuracy	+/- 0.07% of Measurement + .002 Hz
Min counter input amplitude	25% of span (0V center) for freq and pulse counters, 90% of span for others
Pulse counter range	64000000 maximum. (16 bit display resolution)
Pulse width accuracy	0.7 μ s + .00167% of span
Pulse width range	10 μ s - 40000 μ s
Period width accuracy	.02% of measurement + .00167% of span with a maximum of 1.00 μ s
Period width range	12.5 μ s - 90000 μ s (11 Hz - 80 KHz)

Duty cycle accuracy	.5% (Inputs in the 15 Hz - 10 KHz range with 20% - 80% duty cycles)
Connector	Guarded banana jacks (red/black)
Input	Differential, DC coupled
Bandwidth	60 KHz (-3dB)
Off Ground Measurements	Yes
Zero Suppression	Yes, digital
Attenuator Ranges	40, 200 and 1000 Volt (1 VFS to 2000 VFS)
Measurement Ranges	+/- 1000 V (1000 VFS or 2000 VFS w/ zero offset) +/- 200 V (200 VFS or 400 VFS w/ zero offset) +/- 40 V (1 to 40 VFS or 80 VFS w/ zero offset)
Max Rated Input	600 VAC RMS or 1000 VDC Cat IV
Max Transient Input	+/- 2000 V peak
DC Accuracy (25°C)	+/- 0.07% of attenuator
Overshoot	< 1.0%
Intrinsic Noise (pk-pk)	< 0.11% of attenuator + .08% of span (40V att) < 0.04% of attenuator + .08% of span (200V att) < 0.02% of attenuator + .08% of span (1000V att)
IMR at 60 Hz	Better than -65 dB (40V and 200V attenuators) Better than -60 dB (1000V attenuator)
Cold Start Drift	< 0.005% att + .06% span (60 min.)
Min Input Impedance	> 4 Megohm (2 Megohm balanced to internal isolated common)

ITCU-12

Connector	Type U miniature thermocouple
Isolation	250 VRMS or DC, Cat II.
Bandwidth	5 to 6 Hz update rate (TC sampled at 2.5 to 3 Hz)
Absolute Max Input	+/- 10V
Specified Range Type J:	-210 to 1200 °C
Specified Range Type K:	-200 to 1372 °C
Specified Range Type E:	-200 to 1000 °C
Specified Range Type T:	-200 to 400 °C
Specified Range Type N:	-200 to 1300 °C
Specified Range Type B:	600 to 1820 °C (250 to 1820 on menu)
Specified Range Type R:	0 to 1767 °C (-20 to 1768 on menu)
Specified Range Type S:	0 to 1767 °C (-20 to 1768 on menu)
Specified Range Type C:	0 to 2316 °C
A/D	24 bit Sigma Delta
Anti-Aliasing Filter	Inherent
Resolution	0.01 °C
Thermocouple types	J,K,E,T,N,B,R,S,C
Accuracy (25°C) J (<0)	+/- 3.0 °C
Accuracy (25°C) J (0 to 1200)	+/- 1.0 °C
Accuracy (25°C) K (<0)	+/- 2.5 °C
Accuracy (25°C) K (0 to 1372)	+/- 1.5 °C
Accuracy (25°C) E (<-100)	+/- 2.0 °C
Accuracy (25°C) E (-100 to 1000)	+/- 1.0 °C
Accuracy (25°C) T (<-100)	+/- 3.0 °C

Accuracy (25°C) T (-100 to 400)	+/- 1.0 °C
Accuracy (25°C) N (<-50)	+/- 1.5 °C
Accuracy (25°C) N (-50 to 1300)	+/- 0.8 °C
Accuracy (25°C) B	+/- 4.5 °C
Accuracy (25°C) R	+/- 4.0 °C
Accuracy (25°C) S	+/- 4.0 °C
Accuracy (25°C) C (W5ReM26Re)	+/- 2.5 °C
Accuracy (25°C) 100 mV	+/- 0.05% of attenuator
Cold Start Drift	+/- 0.002% of attenuator
Cold Junction Compensation	Yes
Compensation Error	Included in above accuracy specification
IntrinsicNoise (pk-pk, J,N)	< 0.15 °C
IntrinsicNoise (pk-pk, K,E,T)	< 0.10 °C
IntrinsicNoise (pk-pk, B,R,S)	< 1.0 °C
IntrinsicNoise (pk-pk, C)	< 0.5 °C
IntrinsicNoise (pk-pk, 100 mV)	< 0.007 % of attenuator
IMR	> 110 dB @ DC
Linearization	NIST ITS-90
Channels Per Module	12
Note: Specified accuracy does not include probe errors.	

Data acquisition

Recording Method	Internal SATA disk drive
Maximum Sample Rate	800,000 samples/second/channel (module dependent)
Minimum Sample Rate	1 sample/second

Multiple Sample Rates	Up to 4 integer divider sample rates
Total Capacity	1 Terabyte (over 400 million samples)
Time Stamp	Time and Date automatically saved with data
Header	Information on units, range, sample rates, etc. saved with data
Events	Recorded with data
Trigger Types	Edge, window, slew, event, manual, external
Trigger Point	Pre and post trigger is user adjustable (single sample rate)
Auto Re-Arm	Allows automatic stacking of captures

Power

Input Voltage Range	100 to 264 VAC
Frequency Range	47 Hz to 63 Hz
Power Factor	0.99

Optional DC power

Input Range	Regulated 24V (+/- 0.5V)
Input Power	264W Max.

Physical

Enclosure	Aluminum with thermoplastic endcaps
Dimensions (inches)	14.5" x 18.8" x 7.5"
Weight (pounds)	38 (varies based on installed modules)

TMX-R

Dimensions (inches)	15.75" x 18.97" x 18.153"
Weight (pounds)	40.1 (varies based on installed modules)

TMX-E

Dimensions (inches)	14.5" x 18.9" x 5.04"
Weight (pounds)	10.85 (varies based on installed modules)

TMX-VA Optional Software

Synchronizes analog data with video and voice annotation (Requires TMX-VA software upgrade)	
Analog Video Input Type	Composite Video (BNC Connection)
Supported Video Formats	NTSC, PAL
Supported TMX Operating Mode	Realtime & Review
Maximum Capture Length	NTSC: Limited to remaining data capture drive space
	PAL: Limited to 2 Hour data captures
NTSC Capture Resolution	720 x 480 pixels
NTSC Capture Rates	5, 10, 20, 30 frames per second (fps)
PAL Capture Resolution	720 x 576 pixels
PAL Capture Rates	5, 25 fps
Video File Type	AVI with MPEG-4 compression
Audio Resolution	16-bit
Audio Capture Rate	11 kHz
Lookback™ Capability	No

Trigger Capability	Manual Trigger (video provides post trigger recording only)
--------------------	---

TMX-IRIG/GPS Option





Physical	
Type	PCI Card
Timing connector	15-pin D-shell with supplied synchronization cable (BNC)
GPS Antenna connector	SMB socket
IRIG Time Input	
Supported Time Codes	IRIG A, B, E, G, NASA36, GPS
Time Code Type	AM or TTL (DCLS)
Time drift	< 10mS / hour (with calibration to source)
Maximum AM Input Voltage	8 Vpp
Minimum AM Input Voltage	1 Vpp
AM Input Impedance	>5kΩ, AC Coupled
AM Ratio Range	2:1 to 4:1
TTL (DCLS) Range	5V HCMOS, >2V high, <0.8V low
System Functions	
Realtime Display	Synchronized to selected time source
Data Capture Time	Synchronized to selected time source
Scope Mode Time	Latched to selected time source

B

Icon descriptions





Common system icons













The following list describes the functions of common icons.













Icon	Description
	OK saves the information entered in a window and then closes the window.
	Exit cancels the action being performed in a window and closes the window without saving any changes.
	Apply saves the information modified in a window without closing the window.
	Select All selects/highlights all items in a list box.
	Clear Selection removes the selections/highlights from all items in a list box.









Realtime mode control panel

This section describes all icon buttons that can be added to the Realtime mode control panel.

Icon	Description
	Load Signals File loads a signal setup file. <i>File >> Signals</i>
	Load View File loads a view setup file. <i>File >> View</i>
	Load Control Panel File loads a control panel setup file. <i>File >> Control Panel</i>
	Load Capture File loads a data capture setup file. <i>File >> Capture</i>
	Load Trigger File loads a trigger setup file. <i>File >> Trigger</i>





Icon	Description
	<p>Load Global File loads a global setup file. <i>File >> Global</i></p>
	<p>Print Screen prints the contents of the display. This function is available only when a printer is installed. <i>File >> Print Screen</i></p>
	<p>Go to Scope launches Scope mode. <i>Configuration >> Scope</i></p>
	<p>Go to Review launches Review mode. <i>Configuration >> Review</i></p>
	<p>Go to Utilities launches the Utilities screen. <i>Configuration >> Utilities</i></p>
	<p>View Wizard opens the Display Wizard window, which is used to set up grid and event display options. <i>View >> Wizard</i></p>
	<p>Add Grid opens the Grid Properties window, which is used to set up a new grid. <i>View >> Add Grid</i></p>
	<p>Add Event opens the Event Properties window, which is used to set up a new event. <i>View >> Add Event</i></p>
	<p>Monitor Run/Halt starts and stops the on-screen display from running. <i>View >> Monitor Run/Halt</i></p>
	<p>Video Preview opens the TMX Video window, which is used to view video. <i>View >> Video Preview</i></p>
	<p>Channel Information displays and hides the Channel Information window, which is used in conjunction with cursors to measure signals. <i>Analysis >> Channel Information</i></p>
	<p>Meter opens the Meter Properties window, which is used to set up a meter. <i>Analysis >> Meter</i></p>
	<p>XY Plot opens the XY Properties window, which is used to set up an XY plot. <i>Analysis >> XY</i></p>













Icon	Description
	Realtime Settings opens the Realtime Settings window, which is used to configure Realtime mode. <i>Settings >> Realtime</i>
	Channel Settings opens the Channel Settings window, which is used to set up amplifier inputs, base channels, derived channels, and event inputs. <i>Settings >> Channels</i>
	Scale to Levels opens the Scale to Levels window, which is used to set up engineering units based on DC levels. <i>Settings >> Scale to Levels</i>
	Reset Counter resets the frequency counter for the specified channel. <i>Settings >> Reset Counter</i>
	Control Panel Settings opens the Panel Settings window, which is used to set up control panel icons. <i>Settings >> Control Panel</i>
	Set Speed changes the speed of the on-screen chart. In this example, the chart speed will be changed to 5 mm/s when the icon is pressed. Custom speed icons can be configured during the control panel setup process. <i>Settings >> Speed >> mm/s or mm/m</i>
	Cursor A displays and hides cursor A. <i>Cursors >> Cursor A</i>
	Cursor B displays and hides cursor B. <i>Cursors >> Cursor B</i>
	Active Cursor changes the active cursor between A, B, or A & B. <i>Cursors >> Active Cursor</i>
	Move Cursor Left moves the active cursor(s) to the left each time the icon is pressed. <i>Cursors >> Move Left</i>
	Move Cursor Right moves the active cursor(s) to the right each time the icon is pressed. <i>Cursors >> Move Right</i>
	Capture Settings opens the Capture Settings window, which is used to configure data capture setup options. <i>Capture >> Capture Settings</i>
	Trigger Settings opens the Trigger Settings window, which is used to set up data capture triggers and aborts. <i>Capture >> Trigger/Abort Settings</i>













Icon	Description
	Arm Capture arms (starts) a data capture using the configured data capture setup options. <i>Capture >> Arm</i>
	Manual Trigger triggers a data capture manually. <i>Capture >> Manual Trigger</i>
	Abort Capture cancels the data capture in progress. <i>Capture >> Manual Abort</i>
	Trigger Indicator indicates when a trigger occurs by displaying a yellow circle. <i>Capture >> Trigger Indicator</i>
	Capture Indicator indicates when a data capture is in progress by illuminating. <i>Capture >> Capture Indicator</i>
	Calculator launches the Calculator application, which is part of the Windows operating system. <i>Service >> Calculator</i>
	Run/Halt starts and stops the printed chart. <i>Chart >> Run/Halt</i>
	Operations Manual opens the operations manual. <i>Help >> Operations Manual</i>











Scope mode control panel

This section describes all icon buttons that can be added to the Scope mode control panel.

Icon	Description
	Load Signals File loads a signal setup file. <i>File >> Signals</i>
	Load View File loads a view setup file. <i>File >> View</i>
	Load Control Panel File loads a control panel setup file. <i>File >> Control Panel</i>
	Load Capture File loads a data capture setup file. <i>File >> Capture</i>













Icon	Description
	Load Trigger File loads a trigger setup file. <i>File >> Trigger</i>
	Load Global File loads a global setup file. <i>File >> Global</i>
	Print Screen prints the contents of the display. This function is available only when a printer is installed. <i>File >> Print Screen</i>
	Save as Data Capture Record archives an entire scope capture, the currently displayed page of the capture, or the portion of the capture between cursors. <i>File >> Save as Data Capture Record</i>
	Go to Realtime launches Realtime mode. <i>Configuration >> Realtime</i>
	Go to Review launches Review mode. <i>Configuration >> Review</i>
	Go to Utilities launches the Utilities screen. <i>Configuration >> Utilities</i>
	View Wizard opens the Display Wizard window, which is used to set up grid and event display options. <i>View >> Wizard</i>
	Add Grid opens the Grid Properties window, which is used to set up a new grid. <i>View >> Add Grid</i>
	Add Event opens the Event Properties window, which is used to set up a new event. <i>View >> Add Event</i>
	Trigger Line shows and hides the trigger line in the waveform display area. <i>View >> Trigger Line</i>
	IDs displays an identification label for each channel in the waveform display area. <i>View >> IDs</i>
	Channel Information displays and hides the Channel Information window, which is used in conjunction with cursors to measure signals. <i>Analysis >> Channel Information</i>















Icon	Description
	Meter opens the Meter Properties window, which is used to set up a meter. <i>Analysis >> Meter</i>
	XYY Plot opens the XYY Properties window, which is used to set up an XYY plot. <i>Analysis >> XYY</i>
	Fourier Transform opens the Fourier Transform Properties window. <i>Analysis >> Fourier Transform</i>
	Scope Settings opens the Scope Settings window, which is used to configure scope captures. <i>Settings >> Scope</i>
	Channel Settings opens the Channel Settings window, which is used to set up amplifier inputs, base channels, derived channels, and event inputs. <i>Settings >> Channels</i>
	Control Panel Settings opens the Panel Settings window, which is used to set up control panel icons. <i>Settings >> Control Panel</i>
	Increase Timebase increases the timebase used for scope captures. <i>Settings >> Timebase Up</i>
	Decrease Timebase decreases the timebase used for scope captures. <i>Settings >> Timebase Down</i>
	Pre-Trigger Percent opens the Pre-Trigger Percent window, which is used to enter the percent of the scope capture allocated for pre-trigger data. <i>Settings >> Pre-Trigger Percent</i>
	Scope Arm/Abort arms and aborts scope captures. <i>Settings >> Arm/Abort</i>
	Cursor A displays and hides cursor A. <i>Cursors >> Cursor A</i>
	Cursor B displays and hides cursor B. <i>Cursors >> Cursor B</i>
	Active Cursor changes the active cursor between A, B, or A & B. <i>Cursors >> Active Cursor</i>















Icon	Description
	Move Cursor Left moves the active cursor(s) to the left each time the icon is pressed. <i>Cursors >> Move Left</i>
	Move Cursor Right moves the active cursor(s) to the right each time the icon is pressed. <i>Cursors >> Move Right</i>
	Capture Settings opens the Capture Settings window, which is used to configure data capture setup options. <i>Capture >> Capture Settings</i>
	Trigger Settings opens the Trigger Settings window, which is used to set up data capture triggers and aborts. <i>Capture >> Trigger/Abort Settings</i>
	Arm Capture arms (starts) a data capture using the configured data capture setup options. <i>Capture >> Arm</i>
	Manual Trigger triggers a data capture manually. <i>Capture >> Manual Trigger</i>
	Abort Capture cancels the data capture in progress. <i>Capture >> Manual Abort</i>
	Trigger Indicator indicates when a trigger occurs by displaying a yellow circle. <i>Capture >> Trigger Indicator</i>
	Capture Indicator indicates when a data capture is in progress by illuminating. <i>Capture >> Capture Indicator</i>
	Calculator launches the Calculator application, which is part of the Windows operating system. <i>Service >> Calculator</i>
	Operations Manual opens the operations manual. <i>Help >> Operations Manual</i>







Review mode control panel

This section describes all icon buttons that can be added to the Review mode control panel.

Icon	Description
	Archive File archives an entire capture, the currently displayed page of the capture, or the portion of the capture between cursors. <i>File >> Archive File</i>
	Print Screen prints the contents of the display. This function is available only when a printer is installed. <i>File >> Print Screen</i>
	Show Next File opens the next file on the selected drive during review. <i>File >> Show Next File</i>
	Show Previous File opens the previous file on the selected drive during review. <i>File >> Show Previous File</i>
	Return to Data Capture Record closes the embedded scope capture and returns to the original data capture file. <i>File >> Return to DCR</i>
	Go to Scope launches Scope mode. <i>Configuration >> Scope</i>
	Go to Realtime launches Realtime mode. <i>Configuration >> Realtime</i>
	Go to Utilities launches the Utilities screen. <i>Configuration >> Utilities</i>
	View Wizard opens the Display Wizard window, which is used to set up grid and event display options. <i>View >> Wizard</i>
	Add Grid opens the Grid Properties window, which is used to set up a new grid. <i>View >> Add Grid</i>
	Add Event opens the Event Properties window, which is used to set up a new event. <i>View >> Add Event</i>
	Trigger Line shows and hides the trigger line in the waveform display area. <i>View >> Trigger Line</i>
	IDs displays an identification label for each channel in the waveform display area. <i>View >> IDs</i>

Icon	Description
	Channel Information displays and hides the Channel Information window, which is used in conjunction with cursors to measure signals. <i>Analysis >> Channel Information</i>
	Meter opens the Meter Properties window, which is used to set up a meter. <i>Analysis >> Meter</i>
	XYY Plot opens the XYY Properties window, which is used to set up an XYY plot. <i>Analysis >> XYY</i>
	Fourier Transform opens the Fourier Transform Properties window. <i>Analysis >> Fourier Transform</i>
	Zoom opens the Select Zoom Area window. <i>Analysis >> Zoom</i>
	Channel Settings opens the Channel Settings window, which is used to set up amplifier inputs, base channels, derived channels, and event inputs. <i>Settings >> Channels</i>
	Control Panel Settings opens the Panel Settings window, which is used to set up control panel icons. <i>Settings >> Control Panel</i>
	Go to Start scrolls the display to the start of the file. <i>Display >> Goto Start</i>
	Go to End scrolls the display to the end of the file. <i>Display >> Goto End</i>
	Go to Trigger scrolls the display to the trigger point in a file. <i>Display >> Goto Trigger</i>
	Go to Cursor A scrolls the display to the location of cursor A. <i>Display >> Goto Cursor A</i>
	Go to Cursor B scrolls the display to the location of cursor B. <i>Display >> Goto Cursor B</i>
	Go to Cursors A and B compresses or expands the display to the portion of the file between cursors A and B. <i>Display >> Goto Cursors A <-> B</i>
	Go to Advanced opens the Advanced Search window, which is used to navigate through the file using specific search criteria. <i>Display >> Goto Advanced</i>

Icon	Description
	Show All compresses the file to fit the entire file on the display. <i>Display >> Show All</i>
	Compress compresses the display of files to fit more of the file on the screen. <i>Display >> Compress</i>
	Expand expands the display of files to fit less of the file on the screen. <i>Display >> Expand</i>
	Scroll Forward scrolls the chart forward. <i>Display >> Scroll Forward</i>
	Scroll Fast Forward scrolls the chart forward quickly. <i>Display >> Fast Forward</i>
	Scroll Stop stops the chart from scrolling. <i>Display >> Scroll Stop</i>
	Scroll Back scrolls the chart backward. <i>Display >> Scroll Backward</i>
	Scroll Fast Back scrolls the chart backward quickly. <i>Display >> Rewind</i>
	Cursor A displays and hides cursor A. <i>Cursors >> Cursor A</i>
	Cursor B displays and hides cursor B. <i>Cursors >> Cursor B</i>
	Active Cursor changes the active cursor between A, B, or A & B. <i>Cursors >> Active Cursor</i>
	Move Cursor Left moves the active cursor(s) to the left each time the icon is pressed. <i>Cursors >> Move Left</i>
	Move Cursor Right moves the active cursor(s) to the right each time the icon is pressed. <i>Cursors >> Move Right</i>
	Capture Settings opens the Capture Settings window, which is used to configure data capture setup options. <i>Capture >> Capture Settings</i>
	Trigger Settings opens the Trigger Settings window, which is used to set up data capture triggers and aborts. <i>Capture >> Trigger/Abort Settings</i>

Icon	Description
	Arm Capture arms (starts) a data capture using the configured data capture setup options. <i>Capture >> Arm</i>
	Manual Trigger triggers a data capture manually. <i>Capture >> Manual Trigger</i>
	Abort Capture cancels the data capture in progress. <i>Capture >> Manual Abort</i>
	Trigger Indicator indicates when a trigger occurs by displaying a yellow circle. <i>Capture >> Trigger Indicator</i>
	Capture Indicator indicates when a data capture is in progress by illuminating. <i>Capture >> Capture Indicator</i>
	Calculator launches the Calculator application, which is part of the Windows operating system. <i>Service >> Calculator</i>
	Operations Manual opens the operations manual. <i>Help >> Operations Manual</i>

Index

A

- Aborts 104
 - Edge 109
 - Enabling 105
 - Event 113
 - Slew 111, 112
 - Window 108
- Alarms 56
- Amplifier input filters 62
- Amplifier inputs 60
- Archiving files 98, 136, 137, 158
- Audio 119
 - Playback 150

B

- Background color 85
- Base channels 69
- Bridge balance 67

C

- Calculator 192
- Calibration password 191
- Capture setup files 119
 - Loading 120, 121
 - Saving 120
- Carry handle 7
- Channel IDs 129, 149
- Channel meters 164
 - Adding 165
 - Editing 166
 - Moving 166
 - Removing 166
 - Resizing 166
 - Types 164
- Context help 4
- Control panel 3, 50
 - Customizing 51
- Control panel setup files 52
 - Loading 53
 - Saving 52
- Copying files 178
- Cursors 161

D

- Data capture
 - Concepts 97
 - Introduction 3
 - Performing 117

- Process 98
 - Setup 100
- Data capture drive 10
 - Formatting 124
- DC bridge wiring 26
- DC input 9
- Defaults 183
- Derived channels 70
 - Examples 71
 - Setup 72
 - Syntax 71
- Display cover 18
- Display Wizard 81
- Drive modules
 - Installing 11
 - Removing 11

E

- Edge aborts 109
- Edge triggers 109
- EHD-USB 33
- Embedded scope captures 133, 134
- Engineering units 55, 75
- Ethernet ports 9
- Event aborts 113
- Event inputs 77
- Event triggers 113
- Events 85
 - Adding 85
 - Editing 86
 - Moving 86
 - Removing 87
 - Styles 85
- External monitor 34

F

- File summary 142
- Filters 56
 - Amplifier input 62
 - Review mode 155
- Fourier Transform windows 173
 - Adding 173
 - Cursors 174
 - Editing 174
 - Moving 174
 - Removing 175
 - Resizing 174
- FTP 179, 180

G

Global setup files 94
 Loading 95, 96
 Saving 95

Grids 82

 Adding 82
 Colors 84
 Editing 83
 Moving 84
 Removing 84
 Resizing 84

Ground connection 10

Grounding 57

H

HC-TMX 22

Help features 4

Host control 4

I

Icon help 5

IHVM-6 input module 29

Input module slots 10

Input modules

 IHVM-6 29
 Installing 24
 ITCU-12 30
 Locations 23
 Removing 24
 UNIV-6 25, 27

Introduction 1

IP address 177

IRIG 42, 44, 102

ITCU-12 input module 30

K

Keyboard 33

Keyboard port 9

L

Language 185

Launch utility 189

LookBack 141

M

Menu bar 3, 49

 Locking 49

Meters 164

 Adding 165
 Editing 166
 Moving 166
 Removing 166
 Resizing 166
 Types 164

Monitor run/freeze 91

Mouse 33

Mouse port 9

N

Notes

 Adding 150

 Editing 149

 Viewing 149

O

Operating System utility 190

Operations manual 5

P

Periodic triggers 116

Power inlet 9

Power switch 8

R

Rackmount model 19

Real-Chart NP 39, 40

Realtime mode 1, 91

 Accessing 91

 Setup 93

Review mode 2

 Filters 155

S

Scope capture 130

 Performing 132

 Setup 130

Scope mode 1, 127

 Accessing 127

Signal inputs 58

Signal setup files 78

 Loading 79

 Saving 78

Slew aborts 111, 112

Slew triggers 111, 112

Software version number 6

Specifications 197

Stand 17

Support 5

System drive 10

System password 191

T

Technical support 5

Time triggers 116

TMX-E 38

TMX-IRIG/GPS 42, 44

TMX-R 19, 20, 21

Touch screen 7

Track view 127, 145
Trigger line 128, 149
Trigger setup files 121
 Loading 123
 Saving 122
Triggers 104
 Edge 109
 Enabling 105
 Event 113
 Periodic 116
 Slew 111, 112
 Time 116
 Window 108

U

UNIV-6 input module 25, 27
USB external hard drive 33
USB flash memory drive 33
USB ports 9
User interface 3
Utilities 183
Utility / DIO port 8, 12
Utility port 191

V

VGA port 9

View setup files 88
 Loading 89
 Saving 88

W

Window aborts 108
Window triggers 108
Windows-based printers 36

X

XY plot templates 170
 Adjusting 172
 Creating 170
 Loading 172
XY plots 167
 Adding 167
 Cursors 169
 Editing 168
 Moving 168
 Removing 169
 Resizing 168

Z

Zoom 175

